

# 2004 PROGRAM

## East Central Iowa Tractor Pullers Association



www.ecitpa.com

**INSIDE**  
**ECITPA Pulling Photos**  
**\* Score Card**  
**\* 2004 Pulling Schedule**  
**- Page 5**

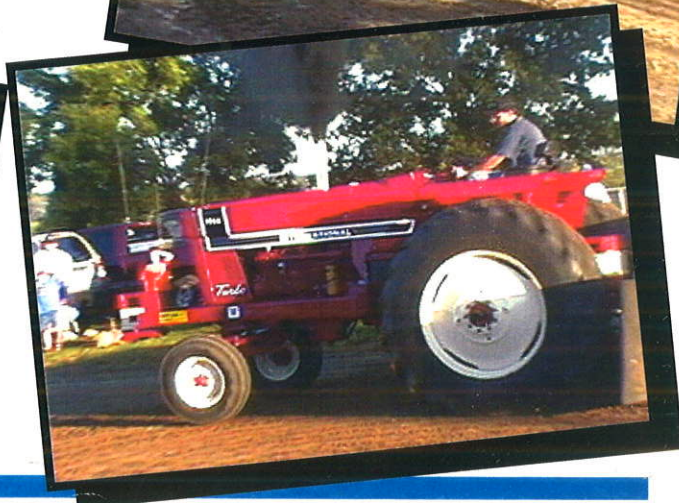
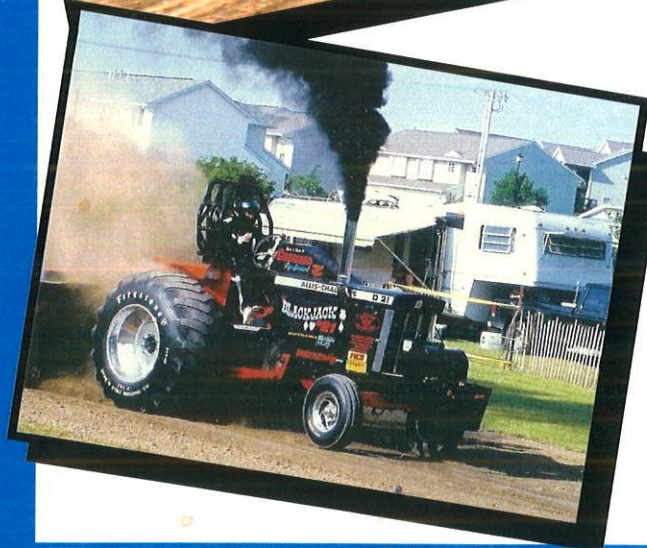



# EAST CENTRAL IOWA TRACTOR PULLERS ASSOCIATION

## Welcome to the 2004 Tractor Pulling Season!

We, the officers, directors and members of the East Central Iowa Tractor Pullers Association would like to thank everyone for making our club a success!

First, we thank the promoters for their time and effort to make each pull a success! We know it takes a lot of work on your part.

Second, we thank the advertisers who donated money to make this program a reality. Please patronize these advertisers whenever possible.

Finally, we thank YOU, the fans, for supporting our shows. We hope you enjoy them and pass the word on to your friends.

Thank you,

Tom Quinlan  
ECITPA President

### ECIPTA MERCHANDISE

can be purchased at the announcer's stand during any ECITPA event.

ECITPA T-shirts ..... \$10  
ECITPA Caps ..... \$10

## 2004 ECITPA Officers

*President:* Tom Quinlan

*Vice President:* Jim Vorwald

*Secretary/Treasurer:* Lynn Vorwald  
Rachel Quinlan

*Tech Officials:* Don Coonrod Jr.  
Tom O'Brien

*Board Delegates:* Ron Bonert  
Randy Cronbaugh  
Brant Greiner  
Dave Jensen  
Steve McElmeel  
Bill McEnany  
Barry Mohr  
Tom O'Brien  
Dave Wickham

## 2003 ECITPA Points Champions: Limited Pro Stock

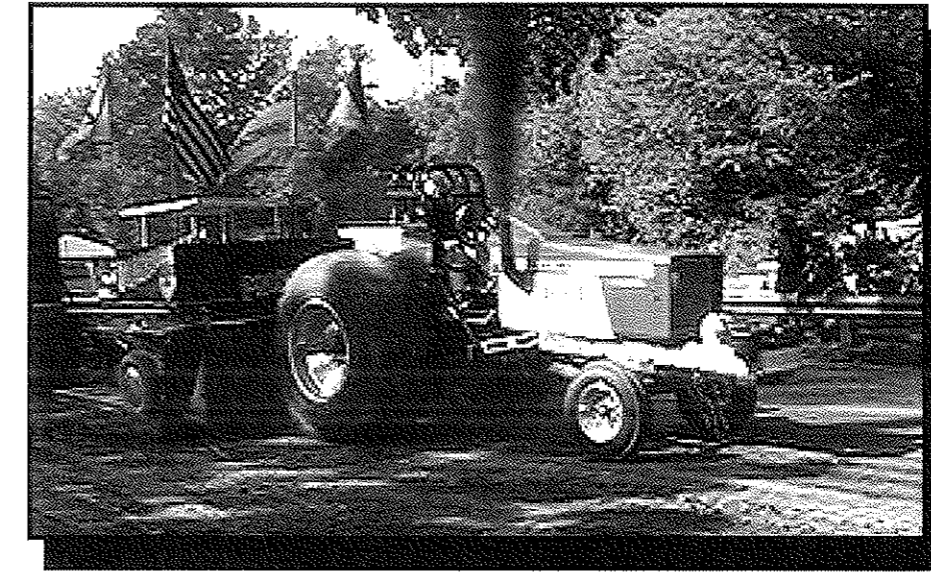

### 6700 lb. Limited Pro Stock Champion

McElmeel Pulling Team  
2nd: Brant Greiner  
3rd: Mohr/Quinlan  
4th: Craig Kinzenbaw  
5th: Cale Hutchings

### 7500 lb. Limited Pro Stock Champion

McElmeel Pulling Team  
2nd: Brandt Greiner  
3rd: Mohr/Quinlan  
4th: Leo Kinzenbaw  
5th: Cale Hutchings

### 8500 lb. Limited Pro Stock Champion

Mike & Jason Schultz  
2nd: Lyle Heiderscheit  
3rd: Jeff Taylor  
4th: Rick Evans  
5th: Bill McEnany

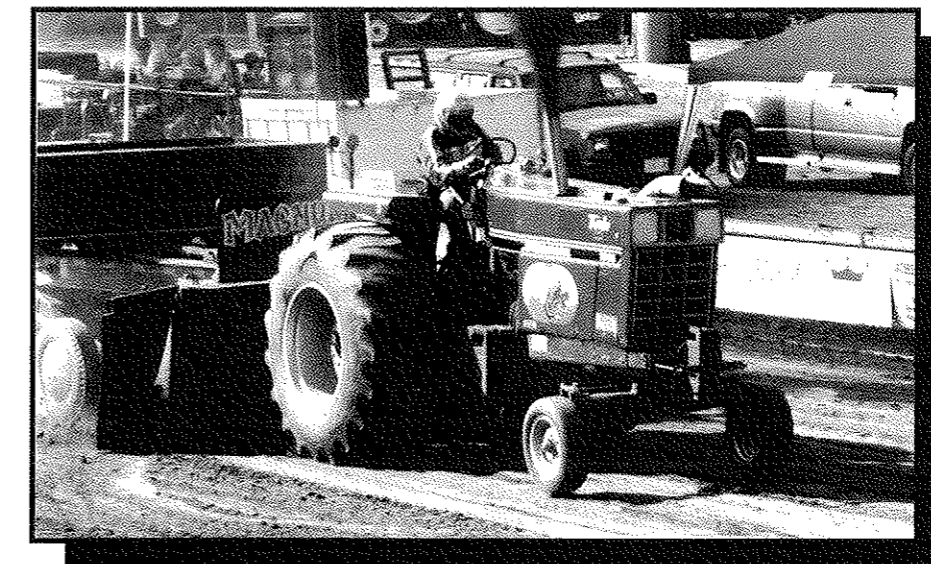

### 9500 lb. Limited Pro Stock Champion

Lyle Heiderscheit  
2nd: Mike & Jason Schultz  
3rd: Jeff Taylor  
4th: Rick Evans  
5th: Bill McEnany

## 2003 ECITPA Points Champions: Pro Farm



**8000 lb.**

← **Pro Farm Champion**

Rick Vanzante  
2nd: Calvin Vangenderen  
3rd: Jim Vorwald  
4th: Harris Steenhoek  
5th: Ron Bonert

← **9000 lb.**

← **Pro Farm Champion**

Rick Van Zante  
2nd: Jim Vorwald  
3rd: Harris Steenhoek  
4th: Ron Bonert  
5th: Calvin Vangenderen

**11000 lb. Pro Farm Champion** →

Herr/Vandonsellaar  
2nd: Chris Peiffer  
3rd: Tom O'Brien  
4th: Perry Sieren  
5th: Bryce Vangenderen



← **12000 lb. Pro Farm Champion**

Chris Peiffer  
2nd: Herr/Vandonsellaar  
3rd: Bryce Vangenderen  
4th: Tom O'Brien  
5th: Perry Sieren

**2003 Rookie of the Year**

Cale Hutchings - LPS  
Ron Steenhoek - PF

**2003 Sportsmanship Award**

Brant Greiner

## 2004 ECITPA Pulling Schedule

May 29	Canton	12:00 PM	....P.F. points: L.P.S. test and tune
June 10	Cedar Rapids Fair	7:00 PM	.....All Classes (1 hook)
June 13	Osceola	12:00 PM	.....Pro Farm Only
June 13	North Liberty Fun Days	1:00 PM	.....L.P.S. Only (2 hooks)
June 18	Kalona	6:00 PM	....All Classes & Trucks (1 hook)
June 26	Riverside	4:00 PM	.....All Classes (1 hook)
July 09	Linn County Fair, Central City	7:00 PM	....All Classes & Trucks (1 hook)
July 12	Wahington	6:30 PM	.....All Classes (1 hook)
July 14	Osage	7:00 PM	.....All Classes (1 hook)
July 15	Tipton	6:30 PM	.....All Classes (1 hook)
July 16	Marengo	6:30 PM	.....All Classes (1 hook)
July 17	Manchester	6:30 PM	.....All Classes (2 hooks)
July 23	Humboldt	7:00 PM	....All Classes & Trucks (1 hook)
July 24	Eldora	6:30 PM	....All Classes & Trucks (1 hook)
July 26	Iowa City	6:30 PM	....All Classes & Trucks (1 hook)
July 29	Columbus Junction	6:30 PM	....All Classes & Trucks (1 hook)
July 30	Maquoketa	6:00 PM	... All Classes & Trucks (2 hooks)
July 31	Dubuque	1:00 PM	... All Classes & Trucks (2 hooks)
August 6	Bellevue	6:00 PM	... All Classes & Trucks (2 hooks)
August 14	Springville	12:00 PM	... All Classes & Trucks (2 hooks)
September 4	Prairieburg	6:00 PM	.....Pro Farm Only
September 5	Blairstown	12:00 PM	... All Classes & Trucks (2 hooks)
September 12	New Vienna	11:00 AM	.....All Classes (2 hooks)

[www.ecitpa.com](http://www.ecitpa.com)

# BARON

## MOTOR SUPPLY

**AUTOMOTIVE  
MACHINE  
SHOP**

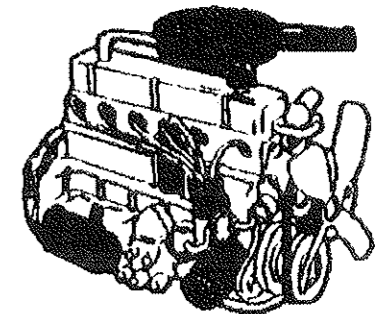
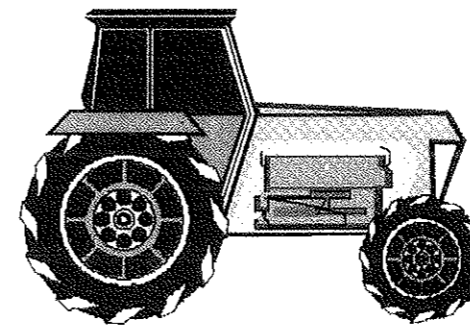

224 3rd Ave. S.W.  
Cedar Rapids, IA 52404

(319) 365-4601  
800-779-4601

## 2004 ECITPA Pulling Rules: Limited Pro Stock

1. Contest is limited to 2 wheel drive pneumatic tired tractors.
  2. Contestants must pay dues and be a member in good standing before pulling. Contestants under 21 must have written consent of parents or guardian and ECITPA Board of Directors. No one under 16 years of age will be allowed to drive.
  3. Tractors may enter only once in each class.
  4. Weight includes drive. Weight must be securely fastened. Weight may be certified at designated pulls. A competing driver may ask to weigh the winning tractor with a tolerance of 2% allowed, if tractor is certified. When a tractor is weighed protestee and protester will be weighed.
  5. Each competitor will be allowed two attempts to make a measurable pull.
    - A. An attempt is defined as moving the sled a measurable distance (one inch or more)
    - B. On his/her first attempt, if competitor lets off on the throttle before going 100 feet, said competitor will get a second attempt, even if he went beyond the 100 foot mark.
    - C. If no attempt is made to back off the throttle, no second attempt will be grant.
- Note: Intent is for driver not to slam on brakes to stop before 100-foot mark (or any time) but to come to a smooth, safe stop.
- D. Cleaning of the track is up to the driver after a false start.
  6. A tractor that does not go 100 feet and stays inbounds will be given a second chance except on pull-offs, where a tractor has only one attempt no matter what distance pulled. If a driver has trouble with his tractor on the first attempt, he may drop to last and has only one attempt. If the sled operator resets the sled, the first puller may drop to last.
  7. The first tractor in each class has the option to come back in 3rd major position. The driver must tell the track judge before he moves away from the sled if he so wishes.
  8. No excessive jerking when starting or during pull.
  9. If tractor hitch breaks, the measurement will be taken at that point.
  10. Tractor pulling the farthest before stopping will be declared the winner of that class. Distance will be measured from front center of sled if manual measuring is required.
  11. Pull is ended when forward motion stops or if tractor goes out of bounds. Excessive digging will not be tolerated.
  12. Contest will be governed by a judge or judges with all decisions being final. Safety will be foremost consideration. Dangerous or unfair practices will be reason for disqualification. Any of the following "A" thru "L" while under the green flag will be automatic disqualification.
    - A. Driver does not remain seated.
    - B. Loss of weight while still hooked to the sled.
    - C. Loss of any safety equipment.
    - D. Loss of any shielding.
    - E. Any time the tractor goes out of bounds.
    - F. If driver shows any unsportsman like conduct the following will occur:

First offense: 0 pints will be awarded to the tractor for that class. Second offense: No points for both classes. Third offense: No points and no money for that day and barred from competition for a year and 1 day.

G. Driver must wear shirt, shoes and full length pants before competing in the pull. Helmet and jacket are required.

H. Severity of punishment is to be at the discretion of the ECITPA board of directors, although a major rules infraction such as illegal entry or flagrant violation of safety rule may cause contestant to be barred from competition for 1 year and 1 day from that date, and/or withdrawal of accumulated points.

I. The ECITPA board of directors resume the right to change, correct, delete, or add any rules that might become necessary during any pulling season.

J. On excessive alcohol consumption:  
 First offense: Contestant does not compete that day and no points award.  
 Second offense: Contestant does not compete that day and loss of points for 1 year.  
 Third offense: Does not compete that day and loss of points for 1 year plus barred from competition for a year and 10 days.

K. Excessive loss of fluids (coolant, motor oil, transmission oil, rear housing oil, water, etc.) while under the green flag.

L. Driver leaves the tractor seat while in the staging area or any time the engine is running or is going to be started.

13. A point system will be used with points awarded to all competing member tractors at all sanctioned events. Tractors must hook to sled under own power and make an attempt to be eligible for points. Points are awarded in this manner:
  - 5 points — To hook to sled as stated above
  - 10 points — First Place
  - 9 Points — Second Place
  - 8 Points — Third Place
  - 7 Points — Fourth Place
  - Down through 10 places, 1 being 10th Place
 Last place points will also be awarded to a tractor which is forced to scratch out of his/her second weight class due to breakage. The tractor doesn't have to hook in class to be awarded these points. No points for a class will be awarded unless the entire class is completed.
14. Only one vote per tractor will be allowed when voting at meetings.
15. Helmets must be on in staging area and remain on until off the track.
16. No riders allowed on tractors—Drivers only!
17. All non-member tractors may be teched at any time at any pull.
18. A floating finish line may be used the discretion of the ECITPA officials. A ten foot maximum. All competitors in a class must be notified before the start of that class. Notification will be posted at the weight scale.
19. A tractor has a three minute time limit to get hooked to the sled when they are to pull.

## 2004 ECITPA Pulling Rules: Pro Farm

1. All ECITPA Pro Farm tractors will be of a stock chassis, engine and frame configuration. Any deviation from this must get board approval.
2. Weight class will be as follows:
  - 8000 lb. Pro Farm - 410 CID or less
  - 9000 lb. Pro Farm - 410 CID or less
  - 11000 lb. Pro Farm - 650 CID or less
  - 12000 lb. Pro Farm - 650 CID or less
3. Turbo chargers - Add-on turbos are allowed. Only one turbo per tractor. There will be a \$500.00 claim on all turbos.
4. RPM - 3000 RPM or less will be enforced and measured off crankshaft with a hand held tachometer. any tractor found over 3000 RPMs after they have pulled will be disqualified immediately and without reimbursement.
5. Tire sizes: 8000 lb. and 9000 lb. classes- 18.4 x 38  
 11000 lb. & 12000 lb. classes - 20.8 x 38 or 18.4 x 42 max.Cut tires are legal.
6. PTO/HYD. - Not required.
7. There will be no water/alcohol injection allowed.
8. 10 mile per hour speed limit enforced. No Add on mph equipment. Pullers will have 150 ft. to get their speed regulated to 10 mph max. Speed will be policed by the sled or pace tractor if needed.
9. No weight protruding beyond the rear tires. Hitch must be free and clear and able to reach with hook without excessive work. Sled operator has right to decline hook to any tractor regarding this matter.
10. Plastic blades verses metal blades are acceptable but not mandatory.
11. Snuffers are mandatory.
12. Wheelie bars are mandatory and must be the same dimensions as Limited Pro Stock.
13. If the speed limit horn sounds, driver may finish pull in a controlled fashion. Failure to do so will result in loss of previously accumulated points.
14. A sensor to check rpms is mandatory before the first pull. First time pullers get 1 courtesy hook without the sensor.
15. ECIPTA reserves the right to make any changes at any time to these rules.
16. All other rules pertaining to contest rules are strictly enforced.

# DIESEL-TURBO SERVICES

## Tractor Repair and Service

1012 1st Ave. N

Mt. Vernon, Iowa

**(319) 895-6092**



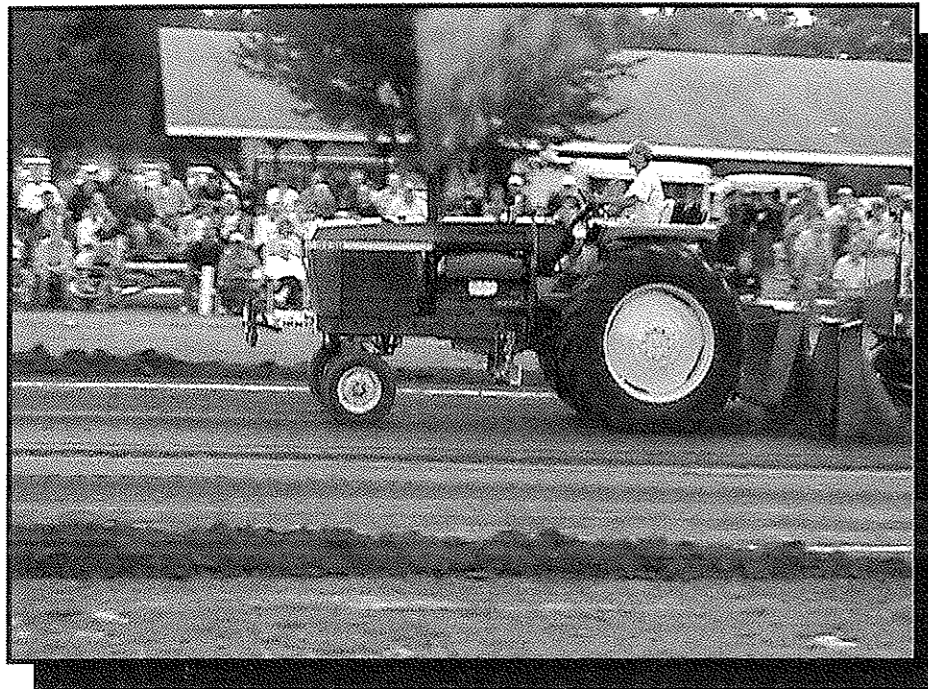

**Brian Sieren**  
 JD 4430  
 8000 lb. & 9000 lb.  
 Pro Farm  
 Washington, IA



**TJ George**  
 NH TM125  
 Yankee Blue  
 6700 lb. & 7500 lb.  
 Limited Pro Stock  
 Indianola, IA

**Farmers 4-County Cooperative**  
 Serving You With Offices In  
 Belle Plaine \* Blairstown \* Chelsea  
 Elberon \* Hartwick \* Ladora \* Luzerne \* Marengo  
 Check Out Our Web Site  
[www.farmers4county.com](http://www.farmers4county.com)

**4-County Cooperative Mission Statement**  
 To be a customer focused cooperative providing quality products and service at competitive prices while achieving growth and profitability.

 **JOHN DEERE**

---

**Southard Implement Co.**

1318 West Street South  
 Grinnell, Iowa 50112  
 641-236-6514 888-524-4020 Fax: 641-236-8339

After Hours Parts:  
 • Steve Vojtech 641-236-6031 • Terry Hudepohl 319-642-3971  
 • Casey Gibbs 641-236-1386 • Marv Honold 641-236-6827

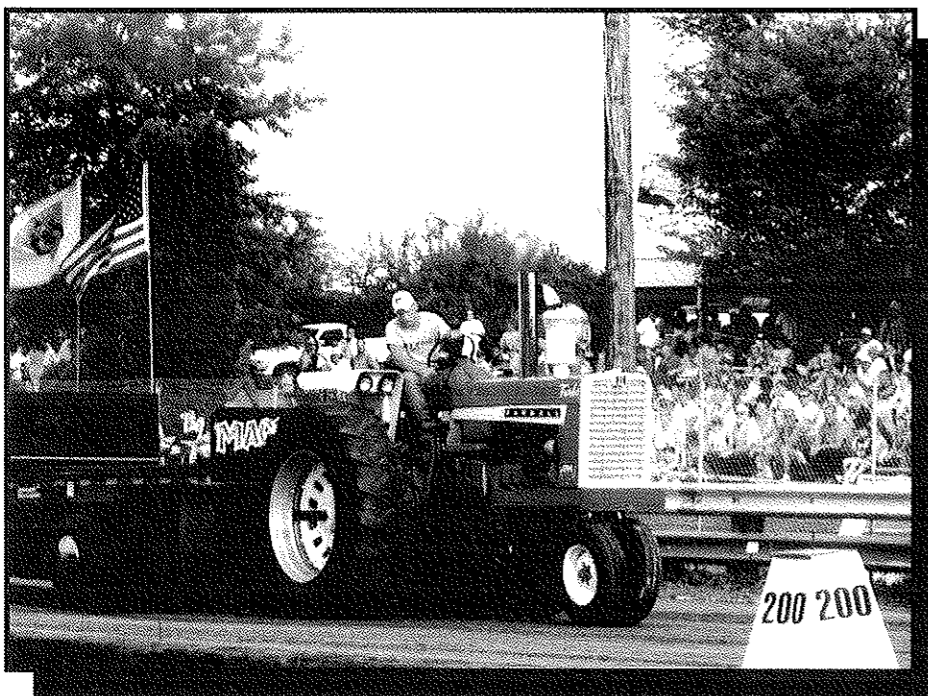

**Willie Brandt**  
 IH 1206  
 8000 lb. & 9000 lb.  
 Pro Farm  
 Ottumwa, IA

**RABE HARDWARE INC.**

**ELECTRICAL • PLUMBING  
 HEATING • COOLING  
 GEOTHERMAL HEAT PUMPS**

**319-454-6514**



**QUALITY SERVICE SINCE 1979**

HEATING **LENNOX** COOLING

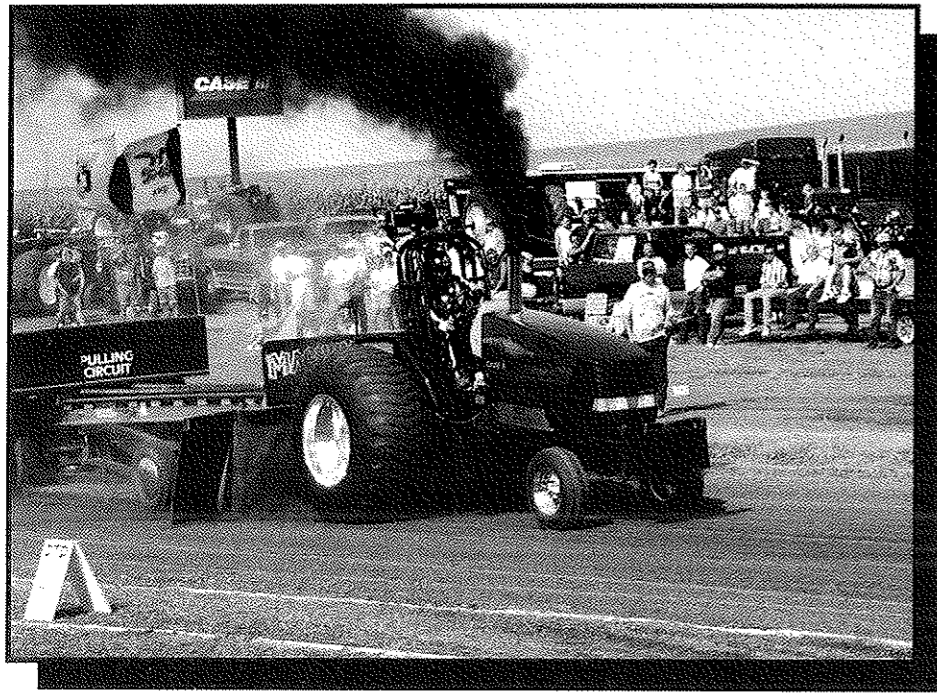

**Lon Cornwell**  
 Mighty Mac  
 MX 170  
 6700 lb. & 7500 lb.  
 Limited Pro Stock  
 Quincy, IL

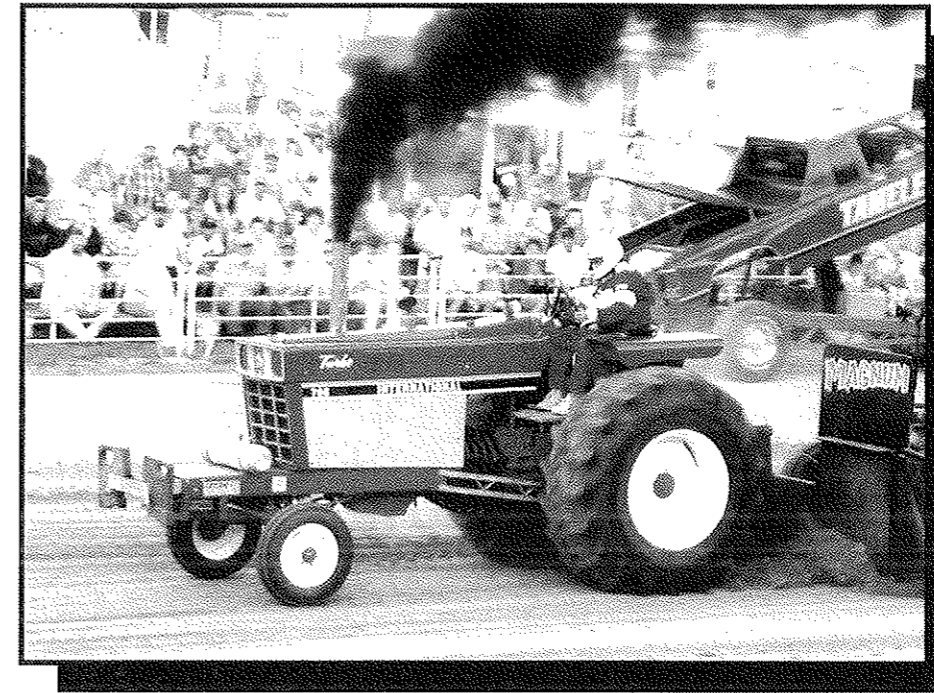

**Brant Greiner**  
 IH 766  
 6700 lb. & 7500 lb.  
 Limited Pro Stock  
 Washington, IA

Major & Minor Repairs

**FRANK'S AUTOMOTIVE**  
 Frank Hamberg, Owner

206 East State • Box 833  
 Williamsburg, Iowa 52361

319-668-1544



**O'GRADY  
 CHEMICAL CORP.**

Fertilizer - Chemicals - Application  
 Trucking - Fuel - LP  
 Tires - Lawn Care  
 200 First Avenue  
 Van Horne, Iowa 52346

**MARTY JUNGE**  
 PRESIDENT

(319) 228-8231

**Steger-Heiderscheit  
 Construction Corp.**

Soil Conservation  
 Terraces - Water Ways - Ponds  
 Highway & Heavy Grading

145 14th Ave. SW Dyersville.....**875-7876**  
 Shop.....875-2404

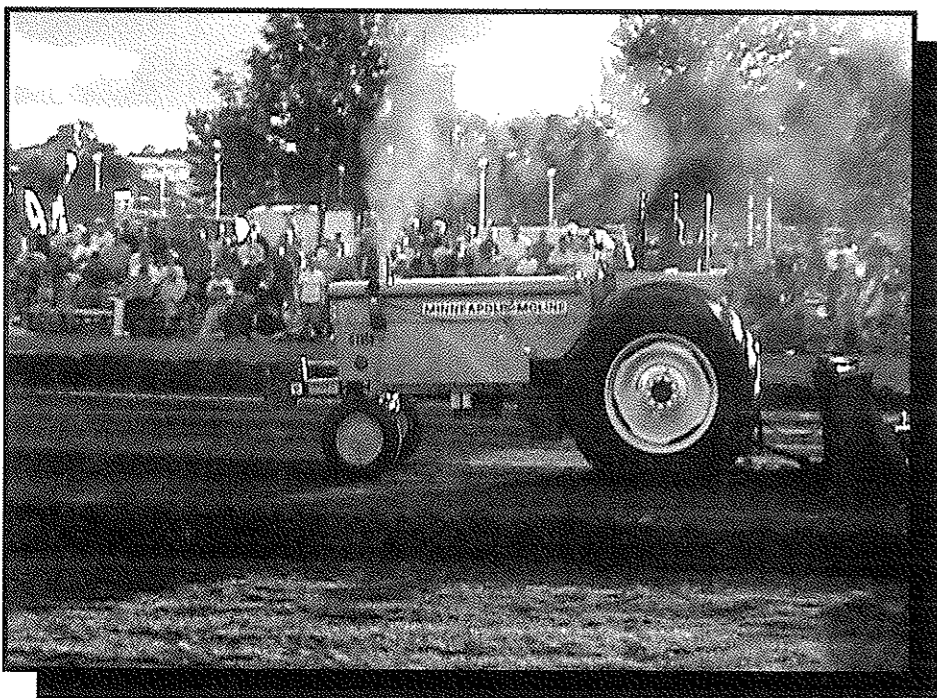

**Marv Stuhrenberg**  
 MM  
 11000 lb. & 12000 lb.  
 Pro Farm  
 Mt. Auburn, IA

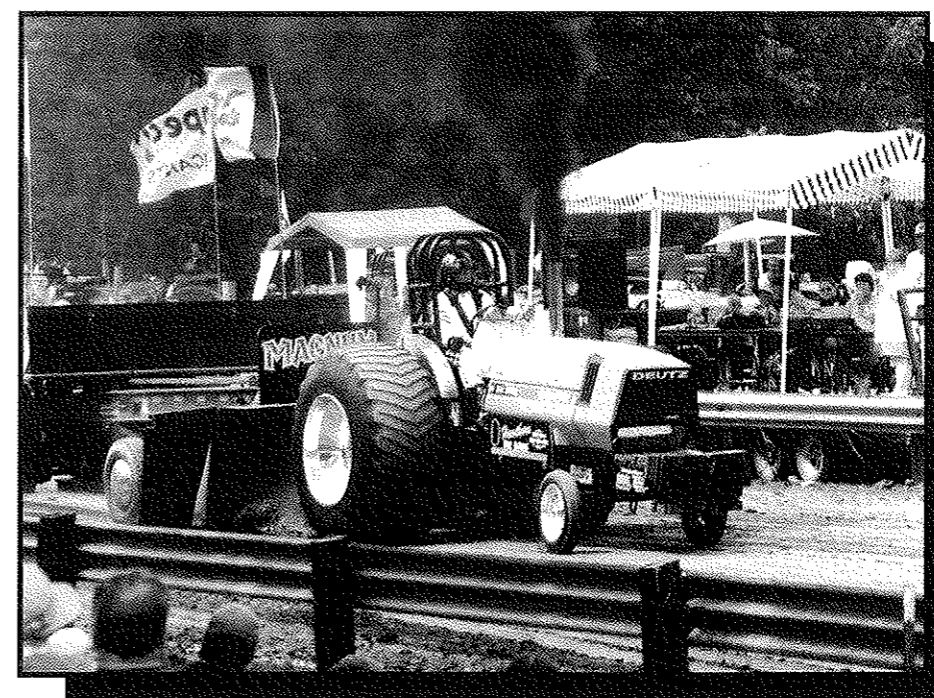

**Larry & Mark Hawthorn**  
 Lil' Green Giant  
 Deutz Dx 8006  
 6700 lb. & 7500 lb.  
 Limited Pro Stock  
 Monticello, WI



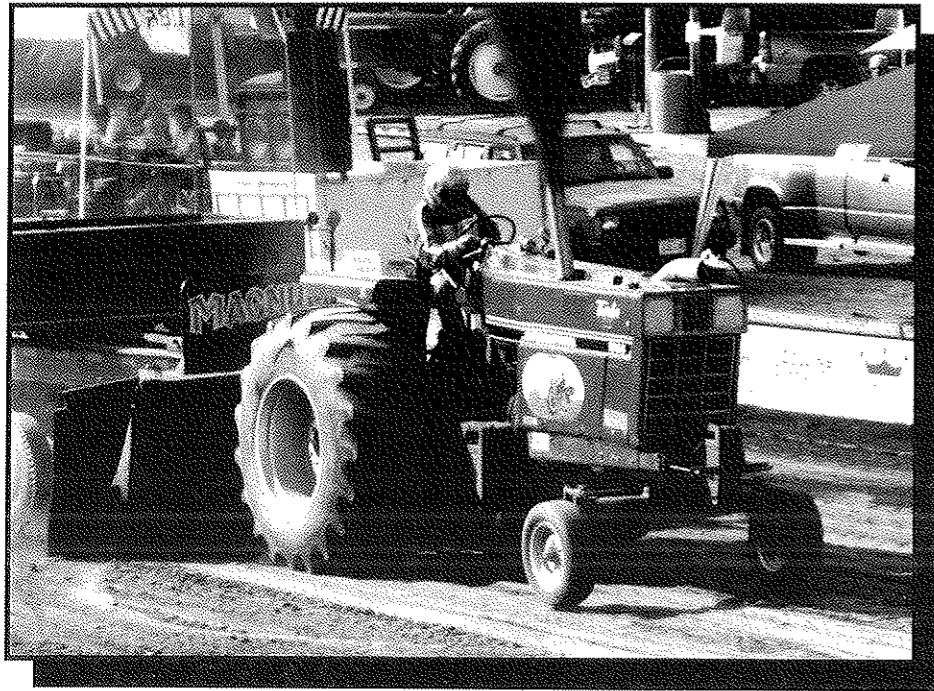

**Lyle Heiderscheit**  
 No Problem  
 IH 1066  
 9500 lb.  
 Limited Pro Stock  
 Epworth, IA

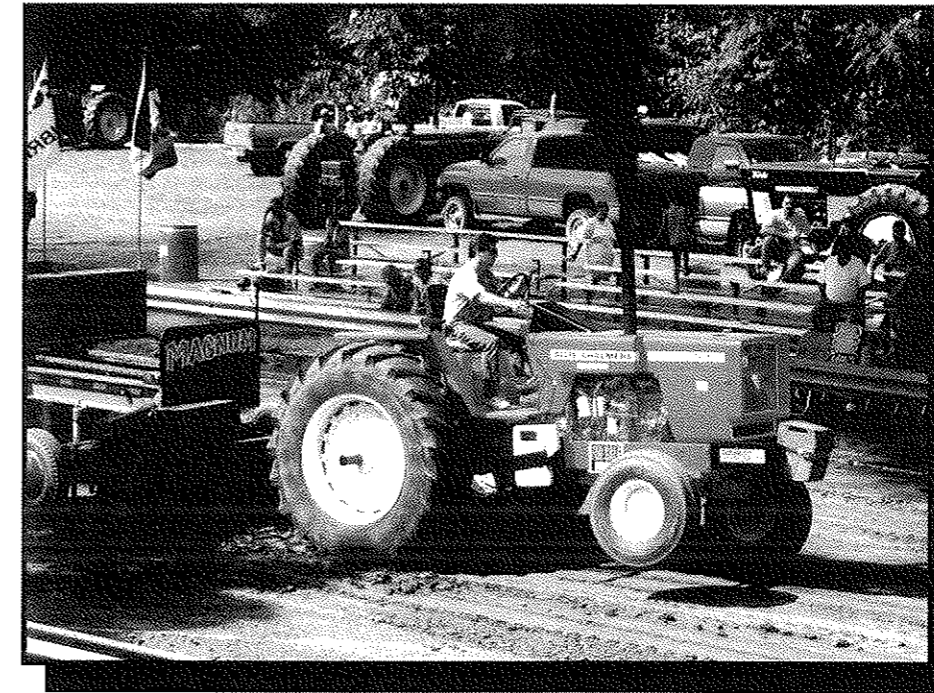

**Pat Heiderscheit**  
 AC 210  
 11000 lb. & 12000 lb.  
 Pro Farm  
 Holy Cross, IA



**VAN GENDEREN TIRE CUTTING**  
*Bryce Van Genderen*  
 641-969-4732  
 All Tires  
 Machine Cut!  
 bvangenderen@iowatelecom.net  
 23529 Hwy. 63 Eddyville, Ia 52553



**KIMM'S  
 MINI-MART  
 SERVICE**  
 604 Locust  
 Blainstown, IA 52209  
 (319) 454-6551



**VIGORTONE® AG PRODUCTS, INC.**  
**Blainstown Feed Mill**  
 Box 146  
 Blainstown, IA 52209  
**319-454-6433**



**Troy Heiderscheit**  
 No Problem  
 IH 1066  
 8500 lb.  
 Limited Pro Stock  
 Epworth, IA

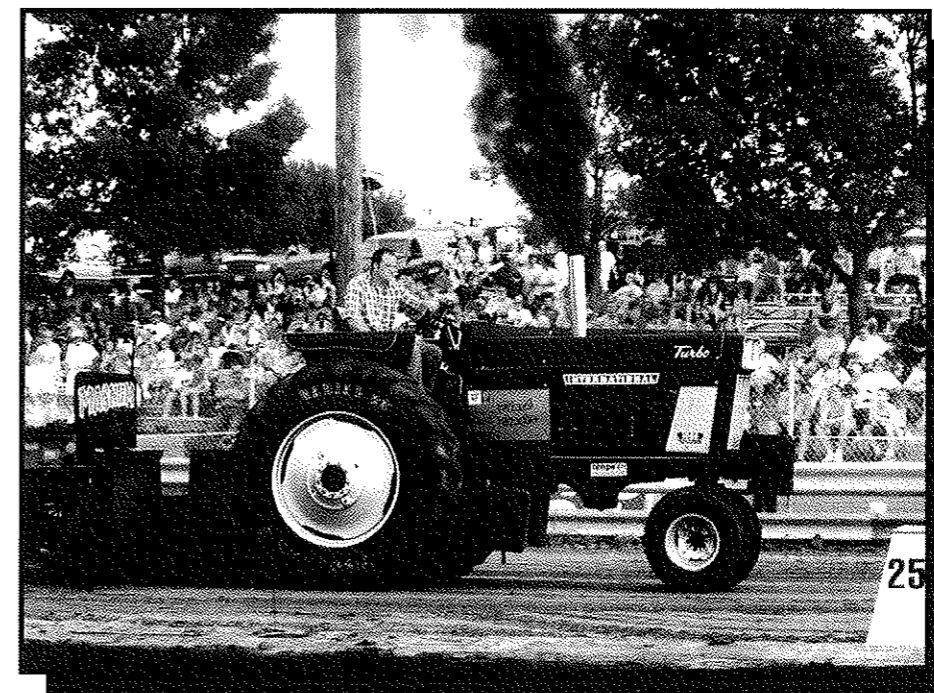

**David Herr**  
 IH 1066  
 11000 lb. & 12000 lb.  
 Pro Farm  
 Fremont, Iowa

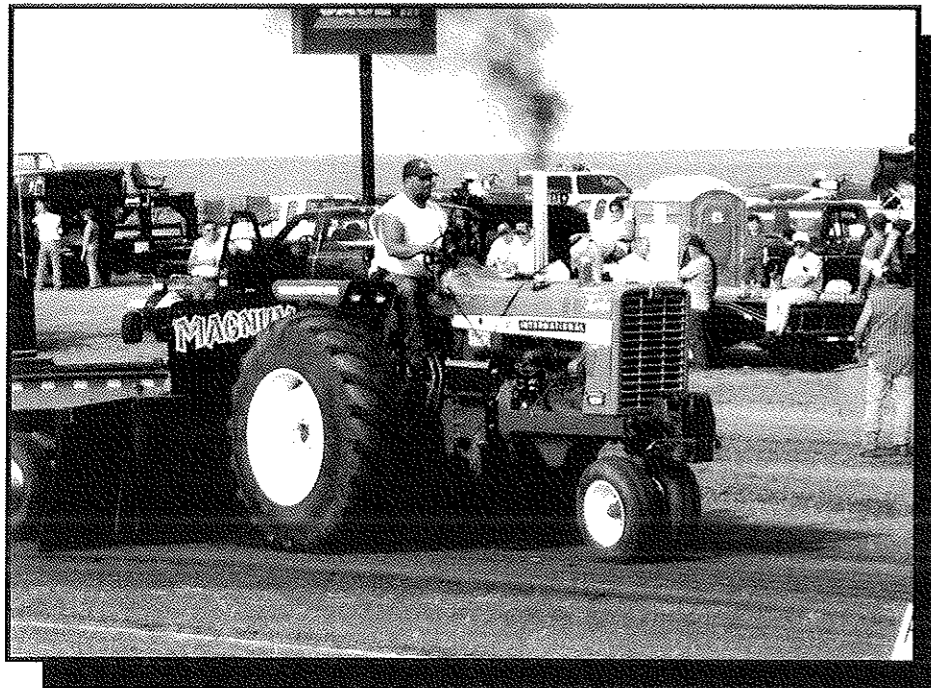

**Jim Vorwald**  
 IH 1256  
 8000 lb. & 9000 lb.  
 Pro Farm  
 Epworth, IA



**Darin & Bill Hynick**  
 JD 4010  
 6700 lb. & 7500 lb.  
 Limited Pro Stock  
 Eddyville, IA



**Hawthorn**  
**TIRE CURING**

Add Life To Your Tires And Keep That Pulling Edge

608-938-4030  
 MONTICELLO, WI



Larry Hawthorn  
 Mark Hawthorn

**BEIFF**  
**COMMODITIES**

*Steve Thompson*      *Wayne Newton*

*Working To Help With  
 Your Risk Management  
 and Trading Needs*

7577 21th Ave  
 Blairstown, IA 52209  
 319-454-6111  
 800-472-0675  
 Fax: 319-454-0034  
 Email: [Beiffe@aol.com](mailto:Beiffe@aol.com)

**STANERSON IMPLEMENT INC.**  
 SALES & SERVICE

Feterl Augers • Bush Hog • Westendorf • Hiniker • Parker  
 Landoll • Landpride • DMI

Keith Stanerson      Conroy, IA 52220  
 319-662-4085      Fax: 319-662-4127

Email: [stanimp@avalon.net](mailto:stanimp@avalon.net)



**Dave Jensen**  
 Uncle Eddie  
 Ford 7910  
 6700 lb. & 7500 lb.  
 Limited Pro Stock  
 Van Horne, IA





**Leo Kinzenbaw**  
 Aunt Allis  
 AC 200  
 7500 lb.  
 Limited Pro Stock  
 Blairstown, IA



**Mike McElmeel**  
 Maverick  
 AC 190  
 6700 lb. & 7500 lb.  
 Limited Pro Stock  
 Rockford, Illinois

**CASE IH**

**Quad County Implement Inc.**  
 2116 76th St., Blairstown, Iowa

**Your full service Dealer**

1-800-779-7140      Visit out website:  
 319-454-6281      [Http://www.netins.net/showcase/quad](http://www.netins.net/showcase/quad)  
 Fax (319) 454-6160      Email us at:  
                                  Quad@netins.net

**cen-pe-co**  
 Central Petroleum Company  
 Since 1911

**Dennis H. Fleeer**      (319) 395-9662  
 Lubrication & Coating Specialist      Cell: 319-560-0066  
 District Representative  
 3310 Timber Valley Court NE  
 Cedar Rapids, IA 52402

Your Dealer for:  
 New Holland      AGCO  
 Gleaner      New Idea  
 White Planters      H & S      Killbros

**HFE Helle Farm Equipment**

14155 Route 136 N, P.O. Box 129  
 Dyersville, Iowa 52040  
 (563)875-7154  
[www.hellefarmequipment.com](http://www.hellefarmequipment.com)

**KUSEL EXCAVATING**  
 \* Waterway Works \* Tree Removal  
 \* Demolition Work \* Basements \* Ponds

\* Dozer  
 \* Dump Truck  
 \* Excavator  
 \* Dirt & Rock Hauling

**GOOD BLACK DIRT FOR SALE**  
**KUSEL EXCAVATING**  
 1090 70TH ST. • ELBERON, IA 52225  
 CELL PHONE 319-551-0721 • OFFICE 319-439-3208



**Craig Kinzenbaw**  
 Aunt Allis  
 AC 200  
 6700 lb.  
 Limited Pro Stock  
 Blairstown, IA



**Bill McEnany**  
 Wasted Nites  
 IH 1066  
 6700 lb. & 7500 lb.  
 Limited Pro Stock  
 Ryan, IA



**Elmer Vandonselaar**  
 IH 1066  
 11000 lb. & 12000 lb.  
 Pro Farm  
 Rose Hill, IA

**Taylor Bros. Construction**  
 John Taylor Joe Taylor  
 Phone 563-870-3565  
 23750 Heiderscheid Road  
 Holy Cross, IA 52053  
*Dozing - Tiling - Scraper - Backhoe*

**Barry Mohr**  
 Malfunction Junction  
 IH 656  
 6700 lb.  
 Limited Pro Stock  
 Ladora, IA

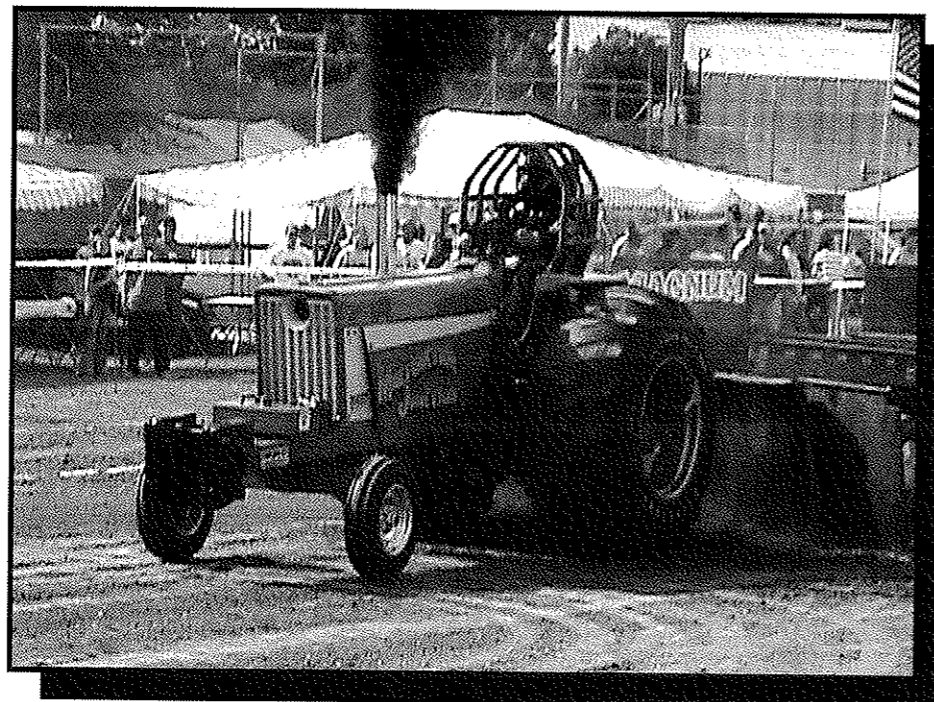

**8000 lb. Class Pro Farm**

PULLER	DISTANCE	RANK
1.	_____	_____
2.	_____	_____
3.	_____	_____
4.	_____	_____
5.	_____	_____
6.	_____	_____
7.	_____	_____
8.	_____	_____
9.	_____	_____
10.	_____	_____
11.	_____	_____
12.	_____	_____
13.	_____	_____

**9000 lb. Class Pro Farm**

PULLER	DISTANCE	RANK
1.	_____	_____
2.	_____	_____
3.	_____	_____
4.	_____	_____
5.	_____	_____
6.	_____	_____
7.	_____	_____
8.	_____	_____
9.	_____	_____
10.	_____	_____
11.	_____	_____
12.	_____	_____
13.	_____	_____

**11,000 lb. Class Pro Farm**

PULLER	DISTANCE	RANK
1.	_____	_____
2.	_____	_____
3.	_____	_____
4.	_____	_____
5.	_____	_____
6.	_____	_____
7.	_____	_____
8.	_____	_____
9.	_____	_____
10.	_____	_____
11.	_____	_____
12.	_____	_____
13.	_____	_____

**12,000 lb. Class Pro Farm**

PULLER	DISTANCE	RANK
1.	_____	_____
2.	_____	_____
3.	_____	_____
4.	_____	_____
5.	_____	_____
6.	_____	_____
7.	_____	_____
8.	_____	_____
9.	_____	_____
10.	_____	_____
11.	_____	_____
12.	_____	_____
13.	_____	_____

**QUINLAN TRUCKING**

**TOM QUINLAN**  
 1420 Grabin Rd NW Oxford, IA 52322  
 HOME PHONE: 319-828-4713  
 SHOP PHONE: 319-828-8070  
 MOBILE PHONE: 319-530-7481

**JOHN DEERE**

**SINDT IMPLEMENT, INC.**  
 7089 15th AVE., Keystone, Iowa  
 NOTHING PULLS LIKE A DEERE  
 Visit our website:  
 1-800-568-4461 www.sindt.com  
 319-442-3249 Email us at:  
 FAX: 319-442-3269 gogreen@sindt.com



**6700 lb. Class Limited Pro Stock**

PULLER DISTANCE RANK

1.	_____	_____	_____
2.	_____	_____	_____
3.	_____	_____	_____
4.	_____	_____	_____
5.	_____	_____	_____
6.	_____	_____	_____
7.	_____	_____	_____
8.	_____	_____	_____
9.	_____	_____	_____
10.	_____	_____	_____
11.	_____	_____	_____
12.	_____	_____	_____
13.	_____	_____	_____

**8500 lb. Class Limited Pro Stock**

PULLER DISTANCE RANK

1.	_____	_____	_____
2.	_____	_____	_____
3.	_____	_____	_____
4.	_____	_____	_____
5.	_____	_____	_____
6.	_____	_____	_____
7.	_____	_____	_____
8.	_____	_____	_____
9.	_____	_____	_____
10.	_____	_____	_____
11.	_____	_____	_____
12.	_____	_____	_____
13.	_____	_____	_____

**7500 lb. Class Limited Pro Stock**

PULLER DISTANCE RANK

1.	_____	_____	_____
2.	_____	_____	_____
3.	_____	_____	_____
4.	_____	_____	_____
5.	_____	_____	_____
6.	_____	_____	_____
7.	_____	_____	_____
8.	_____	_____	_____
9.	_____	_____	_____
10.	_____	_____	_____
11.	_____	_____	_____
12.	_____	_____	_____
13.	_____	_____	_____

**9500 lb. Class Limited Pro Stock**

PULLER DISTANCE RANK

1.	_____	_____	_____
2.	_____	_____	_____
3.	_____	_____	_____
4.	_____	_____	_____
5.	_____	_____	_____
6.	_____	_____	_____
7.	_____	_____	_____
8.	_____	_____	_____
9.	_____	_____	_____
10.	_____	_____	_____
11.	_____	_____	_____
12.	_____	_____	_____
13.	_____	_____	_____



**Gary Willenborg**  
 JD 4010  
 Binder Grinder  
 6700 lb. & 7500 lb.  
 Limited Pro Stock  
 New Vienna, IA

**STORM STEEL**

6111 6th Street S.W.  
 Box 2902  
 Cedar Rapids, Iowa 52406

Dick Behnken  
 Phone 319-362-0522  
 Fax 319-363-8238



**Tom O'Brien**  
 AC  
 11000 lb. & 12000 lb.  
 Pro Farm  
 Cedar Rapids, IA

**Kimm's Ready Mix, Inc.**  
 & Concrete Construction

Agricultural - Residential - Commercial

**Dale P. Kimm Trucking**  
 Aglime - Rock - Sand

Dale P., Joe, and Jon  
**Blairstown, Iowa**  
 319-454-6200



**GARY'S REPAIR**

Ag Equipment Service & Repair

*Over 20 Years Experience*

**(319) 642-5025**

GARY CONRAD                      245 Western Ave.  
 Owner                                  Marengo, Iowa 52301



**Chris Pieffer**  
 IH 1066  
 11000 lb. & 12000 lb.  
 Pro Farm  
 Iowa City, IA



**Tom Quinlan**  
 Malfunction Junction  
 IH 656  
 7500 lb.  
 Limited Pro Stock  
 Oxford, IA



**JOHN DEERE**

Agricultural & Lawn & Garden Equip.  
**Farmers Supply Sales, Inc.**  
 319-656-2291  
 Hwy 22 East Kalona, Iowa

QUALITY  
PRE-OWNED  
VEHICLES

**SHAULL  
&  
ULLERICH**

802 3rd Street  
Victor, Iowa  
**319.647.7500**

**Shaul & Ullerich  
Chevrolet Co.**

*"Our Service Sets Us Apart"*



**319-454-6413**

**Shaul & Ullerich  
Body Shop**

*Painting & Collision Repair Specialists!!*



*Automotive Finishes*

Hwy 82 North • Blairstown, Iowa

**319-454-6190**

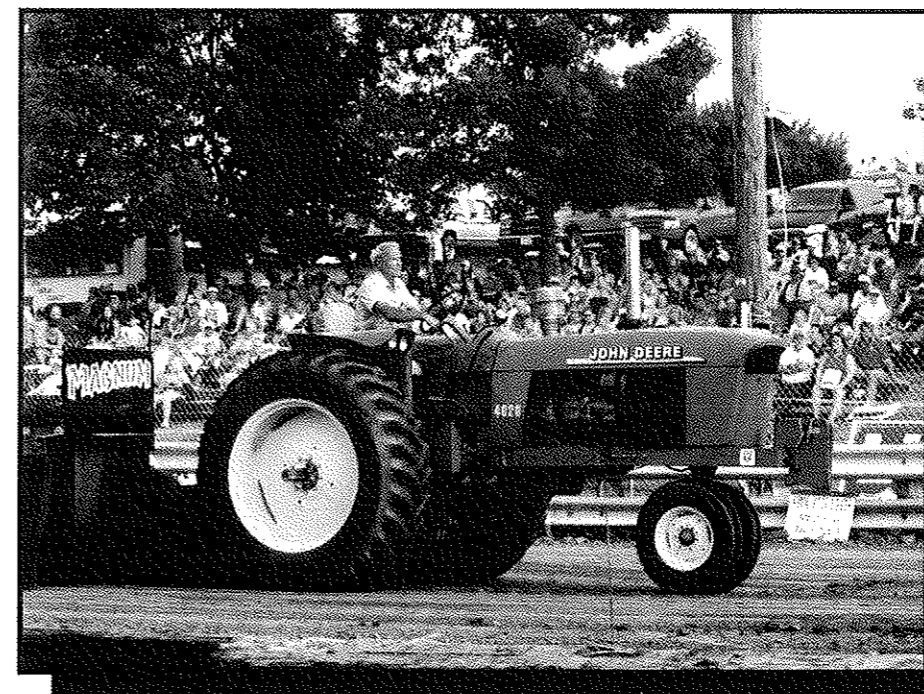

**John Schippers**  
 JD 4020  
 8000 lb. & 9000 lb.  
 Pro Farm  
 Tracy, IA





**Gary & Dan Schulte**  
 Binder Express  
 IH 1066  
 8500 lb. & 9500 lb.  
 Limited Pro Stock  
 New Vienna, IA



**Mike & Jason Schultz**  
 Blackjack 21  
 AC D21  
 8500 lb. & 9500 lb.  
 Limited Pro Stock  
 Bremen, IN

## Vorwald Custom Work

22553 East Pleasant Grove Road  
 Epworth, IA 52045  
 (563) 876-3412

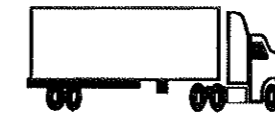

31st ANNUAL

# Blainstown Sauerkraut Days

**LABOR DAY WEEKEND**  
 Friday, Saturday & Sunday  
 Sponsored by Blainstown Lions Club

BIGGER & BETTER  
THAN EVER!!

FUN FOR THE  
ENTIRE FAMILY!!

Friday, Sept 3rd	Saturday, Sept 4th	Sunday, Sept 5th
<p><b>DEMO DERBY</b>            Show Starts 7:30 pm            Entries <b>MUST</b> be            Signed in by <b>6:45</b>            \$5000 Purse            Car &amp; Driver entry fee            \$40.00  <b>CLASSES</b>            Compact Cars            No Weld Cars*Mini vans  <b>ADMISSION</b>            5 &amp; Under Free            6 &amp; Over \$5.00            Pit Pass \$20.00</p>	<p><b>PARADE</b> 10:00 am    <b>CAR SHOW</b> 10:30-3:00 pm  <b>FREE KRAUT &amp; WIENERS</b> 11:00 am (til gone)  <b>ALL DAY IN CITY PARK</b>            Carnival                      Food &amp; Beer Tents            Kid's Games                      Bingo                      Stage Show Entertainment  <b>TOURNAMENTS:</b> Volleyball, Basketball &amp; Co-ed Softball  <b>RIBEYE SUPPER</b> 5:00 - 7:00 pm @ Fire Station  <b>ROLLE BOLLE</b> @ Ball Diamond  <b>KID'S STREET DANCE</b> 6:00 - 10:00 pm FREE Admission  <b>"Jammin' Spool Productions"</b> @ Fire Station  <b>STREET DANCE</b> 9:00 - 1:00 am Admission: \$5.00  <b>"Nite Moves"</b></p>	<p><b>TRACTOR &amp; TRUCK PULL</b>            Show Starts 12:00 pm  <b>ANTIQUA TRACTORS- GARDEN TRACTOR</b>            Beef &amp; Pork Producers            Food &amp; Beer Tents  <b>ROLLE BOLLE</b>            1:15 at Ball Park</p>

*Come and Join the Fun!!!*



**Dave and Dustin Wickham**  
 JD 4030  
 8000 lb. & 9000 lb.  
 Pro Farm  
 Marion, IA



**Harris Steenhoek**  
 JD 4010  
 8000 lb. & 9000 lb.  
 Pro Farm  
 Leighton, IA



**Jeff Taylor**  
 Lil' Red Rooster  
 IH 3688  
 8500 lb. & 9500 lb.  
 Limited Pro Stock  
 Springville, IA



  
**CENTRAL IOWA FARM STORE**  
**KINZE**  
**WOODS.**  
 P.O. Box 561 203 Iowa Ave., W  
 Marshalltown, IA 50158  
 641-753-3996  
 www.centraliowafarmstore.com

**THE IRON ANCHOR**  
  
**DAN WEDEMEIER**  
  
 1471 Fairview Avenue  
 Waverly, IA 50677 • (319) 276-3352



**Mike/Jenny/Steve McElmeel**  
 Maverick  
 AC190XT  
 6700 lb. & 7500 lb.  
 Limited Pro Stock  
 New Sharon, IA

**RURSCH SPECIALTIES**  
  
 12716-148th Ave. West  
 Taylor Ridge, IL 61284  
 (309) 795-1502  
 Fax: (309) 795-1514  
  
 Crower Clutches  
 All Type Clutches Rebuilt  
 Aluminum Fuel Tanks  
 Tire Grinding Discs



**Magnum Pulling Sled**  
 John Vande Vorde  
 2314 120th Street  
 Stanley, Iowa 50671  
 (319) 634-3835





**Byce VanGenderen**  
 JD 4040  
 11000 lb. & 12000 lb.  
 Pro Farm  
 Eddyville, IA



**Raymond Tellin**  
 JD 8410  
 My Wife's New Kitchen  
 8500 lb. & 9500 lb.  
 Limited Pro Stock  
 Maynard, IA



**BECOME A PART  
 OF ECITPA!  
 Associate Memberships**

Any tractor pulling fan can become an associate member of East Central Iowa Tractor Pullers Association. For only \$25 you receive an ECITPA hat or t-shirt, 2 ECITPA decals, and mailings of the latest club information. Just come to the announcer's stand or call Tom Quinlan at 319-828-4713.



**Kinzenbaw Trucking**

Blairstown, IA 52209

Leo 319-454-6565 Craig 319-454-6322  
 Mobile 319-551-1702 Mobile 319-551-2536  
 Fax 319-454-9070

Corn • Soybeans • Grains • Short or Long Hauls

**Blairstown Cafe  
 & Pizzeria**

*Serving Good Food Since 1987*

Nicholas & Aliki Mokas  
 318 Locust Street Blairstown, IA 52209  
 319-454-6900

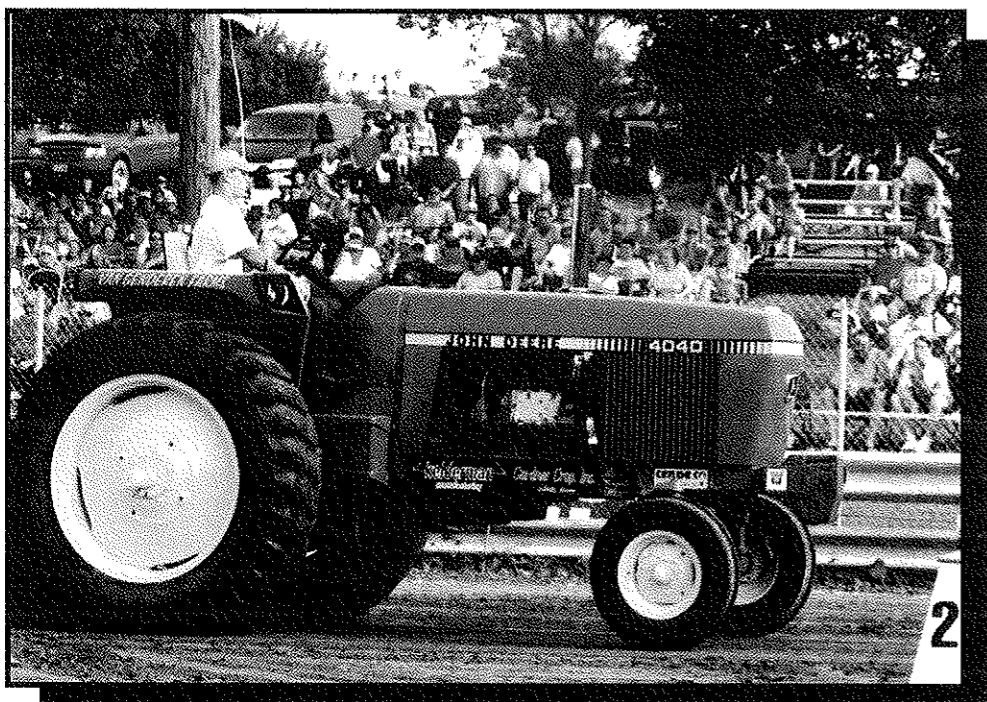

**Calvin Vangendren**  
 JD 4040  
 8000 lb. & 9000 lb.  
 Pro Farm  
 Eddyville, IA

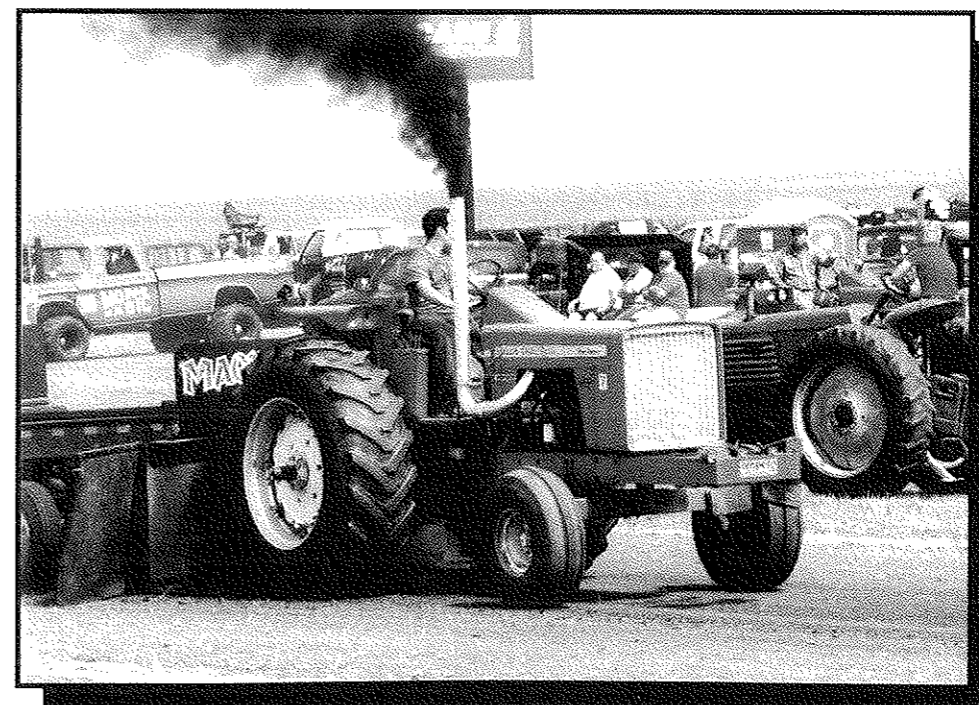

**Rick O'Brien**  
 AC  
 11000 lb. & 12000 lb.  
 Pro Farm  
 Cedar Rapids, IA

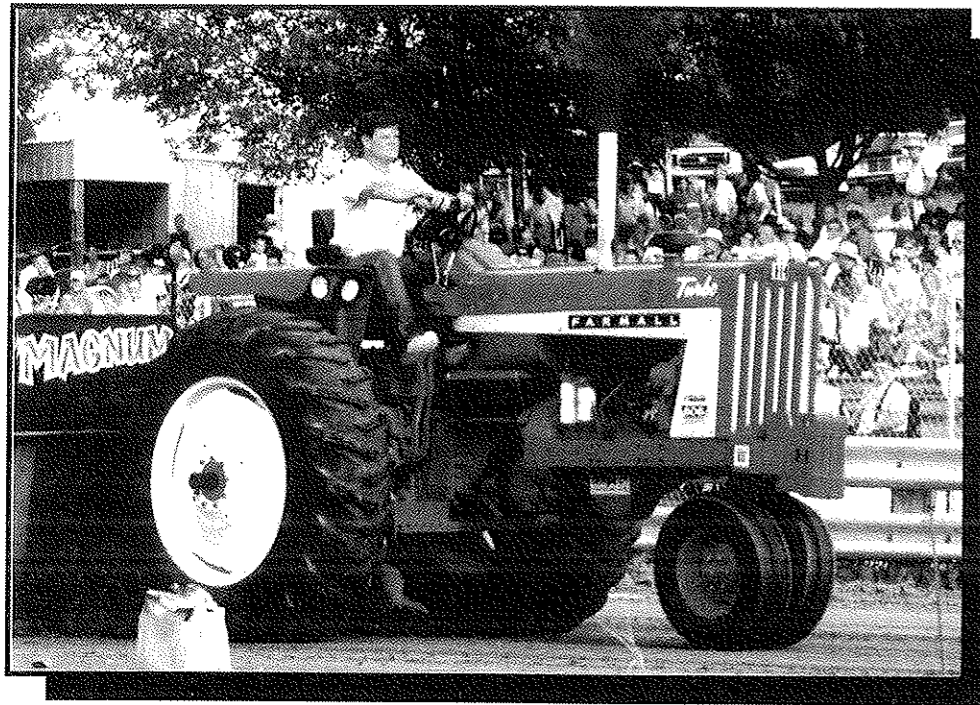

**Rick Van Zante**  
 IH 806  
 8000 lb. & 9000 lb.  
 Pro Farm  
 Pella, IA



**Justin Vorwald**  
 JD 4440  
 8000 lb. & 9000 lb.  
 Pro Farm  
 Epworth, IA

**& Martin Company**  **KELTON SEED FIRMER** **FLY-RITE** 0. DROPTURES

and many other planter attachments.

**Moeller**  
 AG SERVICE

DAVID A. MOELLER Shop 319-698-4005  
 1745 240th St. Home 319-698-2455  
 Keota, IA 52248 E-mail moellerag@se-iowa.net



**RJ Carson**  
 Green Dream  
 JD8520  
 8500 lb. & 9500 lb.  
 Limited Pro Stock  
 Marion, IA

**KUSEL TRUCKING**  
 ELBERON, IA

Stacey Kusel  
 (319) 439-3208  
 Cell: (319) 551-0721



*For all your hopper and van hauling needs!*

**Kinze Farms**  **Home of Aunt Allis**

**Leo Kinzenbaw**  
 Independent Dealer

**DEKALB Genetics Corporation**  
 2045 75TH ST., DR. • BLAIRSTOWN, IA 52209  
 HOME (319) 454-6565 • MOBILE (319) 551-1702

**BENTON QUICK STOP** GAS LOTTO COLD BEVERAGES

**VAN HORNE**  
 "Your Hometown Convenience Stores"



**FAST FRIENDLY SERVICE**

**BLAIRSTOWN**

**BLAIRSTOWN QUICK STOP** PIZZA ICE CREAM GROCERIES

**GARDNER CROP INSURANCE**

209 North Clinton  
 Albia, Iowa 52531

34 years combined Crop Insurance Experience • GPS - Mapping

Call (641) 932-2431 or 800 576-9577  
 Fax (641) 932-3004  
 Tim (Cell) (641) 777-1205 • Jr. (Cell) (641) 777-3917





**Tom Maxwell or  
Tim Offerman**  
11000 lb. & 12000 lb.  
Pro Farm  
Central City, IA

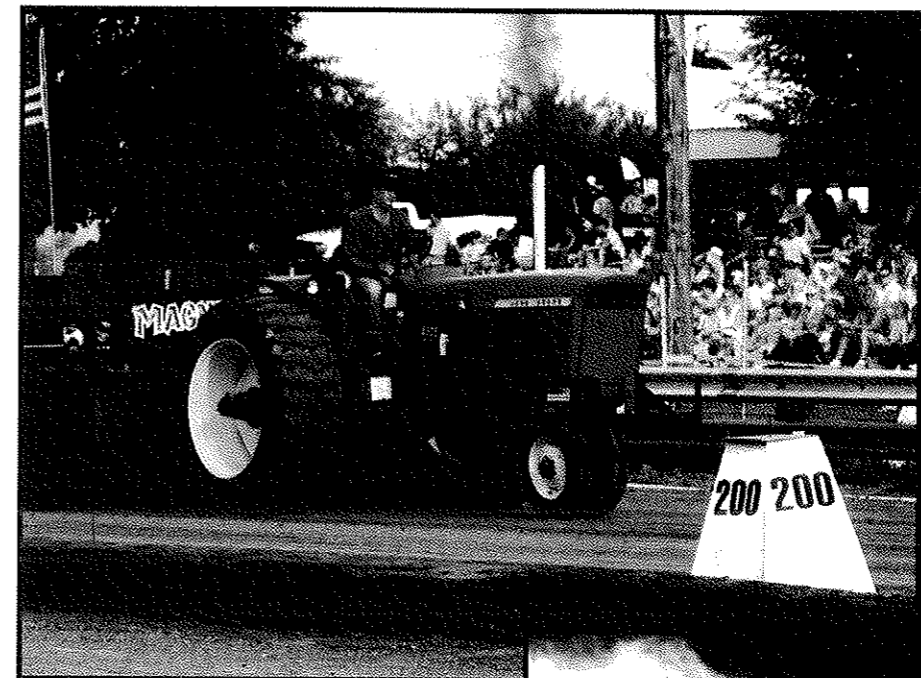

**Ron Bonert**  
JD 4320  
8000 lb. & 9000 lb.  
Pro Farm  
Earlville, IA

**Crop  
Production  
Services**  **Corporate Office**  
P.O. Box 1168  
Fresno, CA 93715-1168

**1115 Holy Cross Rd.  
Farley, Iowa 52046  
Phone: 563-744-3822**

**Rick Evans**  
Bad Things  
IH 966  
8500 lb. & 9500 lb.  
Limited Pro Stock  
Springville, IA



**Perry Sieren**  
JD 6030  
11000 lb. & 12000 lb.  
Pro Farm  
Keota, IA



**Cale Hutchings**  
The Warrior  
AC  
6700 lb. & 7500 lb.  
Limited Pro Stock  
Bloomfield, IA



For the latest up-to-date pulling results  
and more information on ECITPA, please visit  
[www.ecitpa.com](http://www.ecitpa.com)

**ECITPA Members  
(Pictures not available)**

**Paul VandeNoord**  
Red Pride  
MX 200  
Limited Pro Stock  
Pella, IA

**David Ruckle**  
Earl's Dream  
6700 lb. & 7500 lb.  
Limited Pro Stock  
Kent, IL

**GREINER  
CUSTOM  
PUMPING**

**BRANT & AMY GREINER**  
1929 250TH STREET  
WASHINGTON, IA 52353

(319) 653-3989  
Cell: (319) 461-8908  
E-Mail: [brantg@iowatelecom.net](mailto:brantg@iowatelecom.net)

**DRAG HOSE MANURE INJECTION  
SYSTEM**



PHONE 545-2270  
FAX 545-5206

**CHARLIE'S WELDING, INC.**

2363 360TH ST SW  
CHARLES & LINDA STIMMEL TIFFIN, IOWA 52340

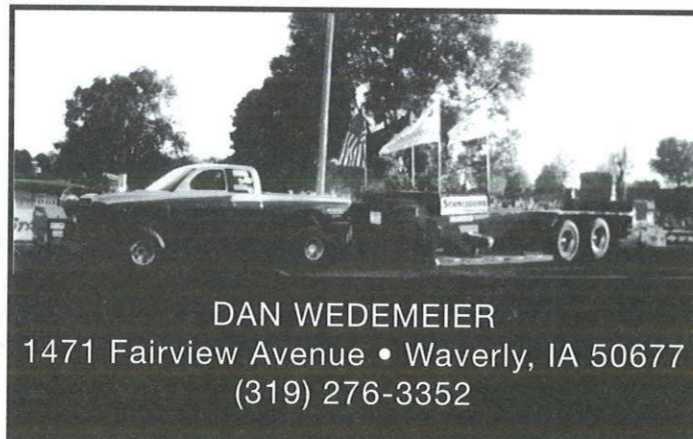

**DAN WEDEMEIER**  
1471 Fairview Avenue • Waverly, IA 50677  
(319) 276-3352



**CEDAR RAPIDS AND DAVENPORT, IOWA**

**Altorfer Power Systems**

2550 6<sup>th</sup> Street SW  
Cedar Rapids, IA 52404  
Phone (319) 365-6500  
Toll Free: (800) 333-5993 x272  
Fax (319) 365-5493  
[WWW.ALTORFER.COM](http://WWW.ALTORFER.COM)



**Altorfer Power Systems**

4712 Buckeye Street  
Davenport, IA 52802  
Phone (563) 324-1935  
Fax (563) 323-3115  
[WWW.ALTORFER.COM](http://WWW.ALTORFER.COM)

**ASK ABOUT OUR GUARANTEED FLAT RATES  
FOR ALL YOUR CATERPILLAR ENGINE SERVICE!!**

Our Mission: To be the undisputed leader in providing business solutions to our customers.

We will "Tell it like it is"

We are customer focused.

We stress teamwork and cooperation.

We have pride in our organization and our product.

We have a "Can do" attitude.



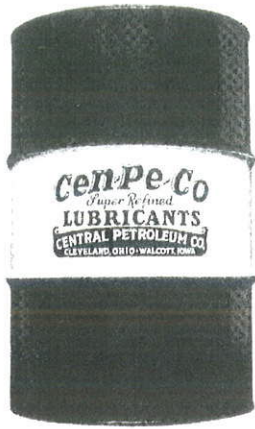

# cen-pe-co<sup>®</sup>

## Lubricants & Coatings

- ◆ Superior Performance Engine Oils
- ◆ Patented Fuel Additives
- ◆ Higher Torque Gear Lubricants
- ◆ Strong Hold Greases
- ◆ Longer Life Metal & Wood Building Paints
- ◆ Aluminum Fibre Roof & Bin Coatings

### Central Petroleum Co.

Cleveland, OH • Walcott, IA

[www.cen-pe-co.com](http://www.cen-pe-co.com)

**1-800-553-1891**



**Kinzenbaw Pulling Team**  
Aunt Allis



**Gary Willenborg**  
Binder Grinder

CEN-PE-CO ALSO MANUFACTURERS COLUMBIA PAINTS AND ROOF COATINGS, THE STRONGEST PROTECTION AGAINST RUST & CORROSION AVAILABLE.



Before Coating



Columbia Sterling Aluminum Fibred Coating

#### Columbia Sterling Aluminum Fibre Roof & Bin Coating:

- Stops Rust Dead in its Tracks - rust warranty available.
- Time Tested - field tested and proven for over 50 years.
- Resists Breakdown -special asphalts and binders resist breakdown and stay flexible.
- Reduce Interior Temperatures - lowers heating and cooling costs.
- Independent Application - available in many areas.
- Over 100,000 - satisfied customers nationwide.



Columbia Acro-Plex Red & White Paint.  
Longer lasting wood paints. Oil or latex.



Columbia Metal Latex Red & White Paint.  
Superior anti-rust protection and beautification for metal buildings