

# East Central Iowa Tractor Pullers, Inc.

## INSIDE

ECITPA  
Pulling Photos

Score Card

2001 Pulling  
Schedule - Page 5

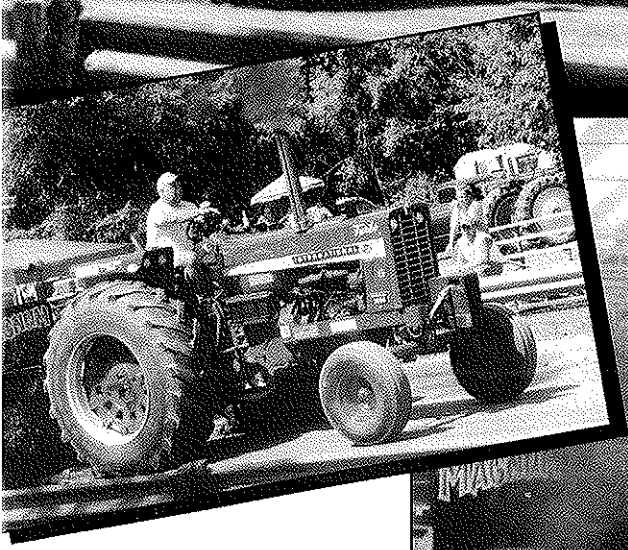
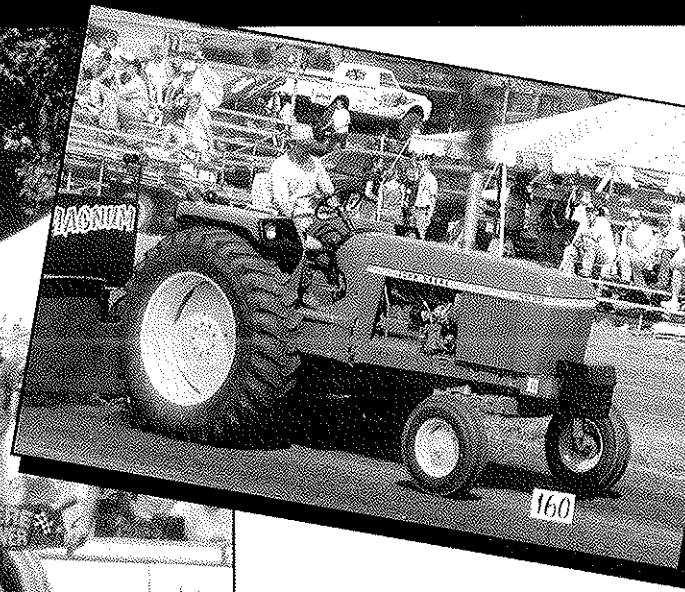

## 2000 ECITPA Points Champions: Farm Stock

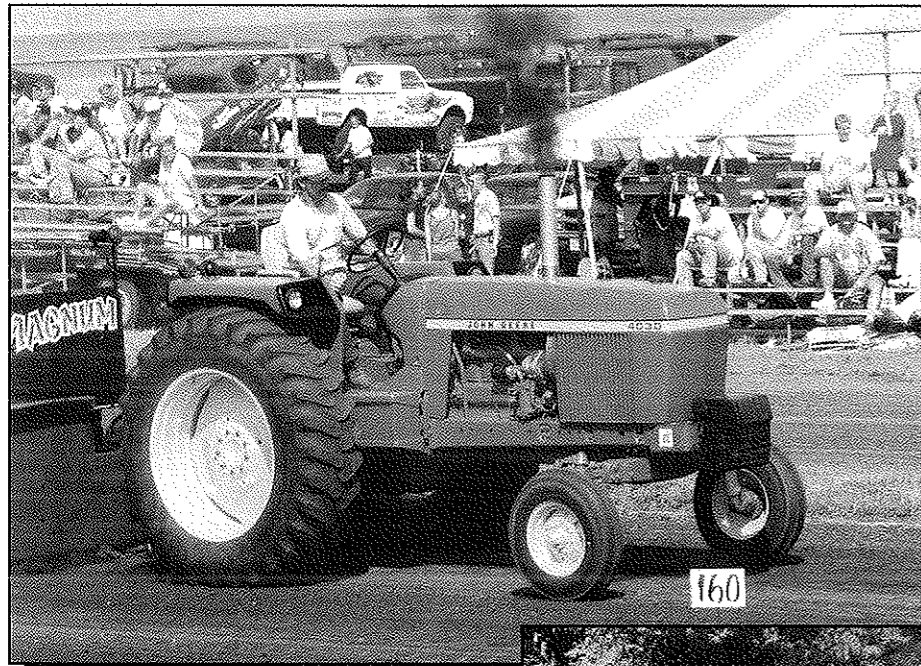

### 8000 lb. Farm Stock Champion

Dave Wickman  
2nd: Doug Jaeger  
3rd: Darin Hynick  
4th: Ron Bonert  
5th: Rick Van Zante

### 9000 lb. Farm Stock Champion

Dave Wickman  
2nd: Bill Hynick  
3rd: Doug Jaeger  
4th: Rick Van Zante  
5th: Ron Bonert

### 11,000 lb. Farm Stock Champion

Mike Baumert  
2nd: Justin Vorwald  
3rd: Marv Stuhrenberg  
4th: Craig Boot  
5th: Jason Schultz

### 12,000 lb. Farm Stock Champion

Mike Baumert  
2nd: Jim Vorwald  
3rd: Marv Stuhrenberg  
4th: Craig Boot  
5th: Jason Schultz



## 2001 ECITPA Pulling Schedule

Friday, June 8 ..... Hawkeye Downs Fair; Cedar Rapids ..... 7:00 PM ..... ECITPA & Twin State  
 Sunday, June 10 ..... North Liberty Fun Days ..... 12:00 PM ..... ECITPA (Super Farm Only)  
 Wednesday, July 4 ..... Sigourney ..... 6:00 PM ..... ECITPA & Twin State  
 Saturday, July 14 ..... Delaware County Fair; Manchester ..... 7:00 PM ..... ECITPA & Twin State  
 Thursday, July 19 ..... Centerville ..... 7:00 PM .. ECI & Twin State(S. Farm Only)  
 Friday, July 20 ..... Washington County Fair; Washington .... 6:30 PM ..... ECITPA & Twin State  
 Wednesday, July 25 ..... Johnson County Fair; Iowa City ..... 6:30 PM ..... ECITPA & Twin State  
 Friday, July 27 ..... Jackson County Fair; Maquoketa ..... 6:00 PM ..... ECITPA  
 Saturday, July 28 ..... Dubuque County Fair; Dubuque ..... 12:00 PM ..... ECITPA  
 Friday, August 3 ..... Bellevue ..... 7:00 PM ..... ECITPA  
 Saturday, August 11 ..... Springville Fun Days ..... 12:00 PM ..... ECITPA  
 Fri. & Sat., Aug. 24 & 25 ..... Oskaloosa ..... 6:00 PM ..... ECITPA  
 Saturday, September 1 ..... Prairieburg ..... 12:00 PM ..... ECITPA (Super Farm Only)  
 Sunday, September 2 ..... Blairstown ..... 12:00 PM ..... ECITPA & Twin State  
 Sunday, September 9 ..... New Vienna ..... 12:00 PM ..... ECITPA

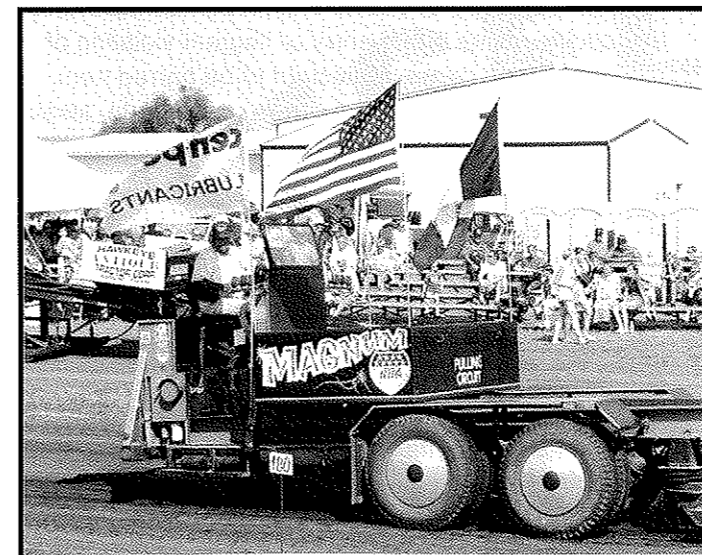

### Magnum Pulling Sled

John Vande Vorde  
2314 120th Street  
Stanley, Iowa 50671  
(319) 634-3835

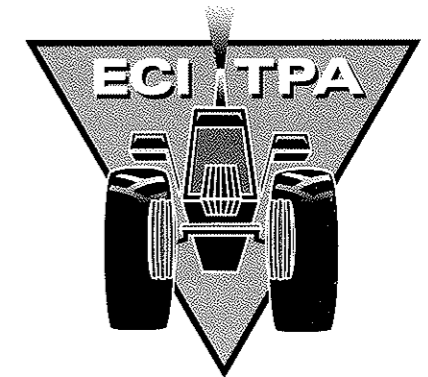

### BECOME A PART OF ECITPA! Associate Memberships

Any tractor pulling fan can become an associate member of East Central Iowa Tractor Pullers Association. For only \$25 you receive a ECITPA hat or t-shirt, 2 ECITPA decals, and mailings of the latest club information. Just come to the announcer's stand or call Tom Quinlan at 319-628-4713.



**ALPINE PLANT FOOD**  
**DENNIS WILLENBORG**  
Regional Sales Manager

**WILLENBORG**  
**LAWN ORNAMENTS**  
CAROL WILLENBORG

6924 Columbus St. MON-SAT - 9 A.M. - 5 P.M.  
New Vienna, Iowa 52065 Sunday by Chance or Appt.  
**(563) 921-4275**



**FLYNN** READY-MIX  
CONCRETE CO  
SERVICE IS OUR BOTTOM LINE

RESIDENTIAL - FARM COMMERCIAL - INDUSTRIAL  
WE SPECIALIZE IN RIVER GRAVEL MIXES  
8 Plants Serving 3 States!



RADIO CONTROLLED  
60 TRUCK FLEET

FREE ESTIMATES  
General Office  
**583-6494**  
12 ST EXT • DUBUQUE

EPWORTH  
**876-3300**  
314 2ND ST N.W.

GALENA  
**777-0452**  
11375 INDUSTRIAL PK



## 2001 ECITPA Pulling Rules: Super Farm

1. Contest is limited to 2 wheel drive pneumatic tired tractors.
  2. Contestants must pay dues and be a member in good standing before pulling. Contestants under 21 must have written consent of parents or guardian and ECITPA Board of Directors.No one under 16 years of age will be allowed to drive.
  3. Tractors may enter only once in each class.
  4. Weight includes driver. Weight must be securely fastened. Weight may be certified at designated pulls. A competing driver may ask to weigh the winning tractor with a tolerance of 2% allowed, if tractor is certified. When a tractor is weighed protestee and protestor will be weighed.
  5. Each competitor will be allowed two attempts to make a measureable pull.
    - A. An attempt is defined as moving the sled a measureable distance (one inch or more)
    - B. On his/her first attempt, if competitor lets off on the throttlet before going 75 feet, said competitor will get a second attempt, even if he went beyond the 75 foot mark.
    - C. If no attempt is made to back off the throttle, no second attempt will be granted.
- Note:* Intent is for driver not to slam on brakes to stop before 75-foot mark (or any time) but to come to a smooth, safe stop.
- D. Cleaning of the track is up to the driver after a false start.
6. A tractor that does not go 75 feet and stays inbounds will be given a second chance except on pull-offs, where a tractor has only one attempt no matter what distance pulled. If a driver has trouble with his tractor on the first attempt, he may drop to last and has only one attempt. If the sled operator resets the sled, the first puller may drop to last.
  7. The first tractor in each class has the option to come back in 3rd major position. The driver must tell the track judge before he moves away from the the sled if he so wishes.
  8. No excessive jerking when starting or during pull.
  9. If tractor hitch breaks, the measurement will be taken at that point.
  10. Tractor pulling the farthest before stopping will be declared the winner of that class. Distance will be measured from front center of sled if manual measuring is required.
  11. Pull is ended when forward motion stops or if tractor goes out of bounds. Excessive digging will not be tolerated.
  12. Contest will be governed by a judge or judges with all decisions being final. Safety will be foremost consideration. Dangerous or unfair practices will be reason for disqualification. Any of the following "A" thru "L" while under the green flag will be automatic disqualification:
    - A. Driver does not remain seated.
    - B. Loss of weight while still hooked to the sled.
    - C. Loss of any safety equipment.
    - D. Loss of any shielding.
    - E. Any time the tractor goes out of bounds.
    - F. If driver shows any unsportsmanlike conduct.
    - G. Driver must wear shirt, shoes and full length pants before competing in the pull. Helmet and jacket are required
    - H. Severity of punishment is to be at the discretion of the ECITPA board of directors, although a major rules infraction such as illegal entry or flagrant violation of safety rule may cause contestant to be barred from competition for 1 year and 1 day from that date, and/or withdrawal of accumulated points.
    - I. The ECITPA board of directors resume the right to change, correct, delete, or add any rules that might become necessary during any pulling season.
    - J. On excessive alcohol consumption:  
First offense: Contestant does not compete that day and no points awarded.  
Second offense: Contestant does not compete that day and loss of points for one year.  
Third offense: Contestant does not compete that day and loss of points for 1 year plus barred from competition for one year and ten days.
    - K. Excessive loss of fluids (coolant, motor oil, transmission oil, rear housing oil, water, etc.) while under the green flag.
    - L. Driver leaves the tractor seat while in the staging area or any time the engine is running or is going to be started.

## 2001 ECITPA Pulling Rules: Farm Stock

1. All ECITPA stock farm tractors will be of a stock chassis, engine and frame configuration. Any deviation from this must get board approval.
2. Weight class will be as follows:  
8000 lb. Farm Stock - 410 CID or less  
9000 lb. Farm Stock - 410 CID or less  
11000 lb. Farm Stock - 650 CID or less  
12000 lb. Farm Stock - 650 CID or less  
There must be 200 lb. of movable weight in all classes.
3. Turbo chargers - 3LM/TO4 or factory replacement turbos are allowed. Add-on turbos are allowed. Only one turbo per tractor. There will be a \$500.00 claim on all turbos.
4. RPM - 3000 RPM or less will be enforced and measured off crankshaft with a hand held tachometer. Any tractor found over 3000 RPMs after they have pulled will be disqualified immediately and without reimbursement.
5. Tire sizes: 8000 lb. and 9000 lb. classes - 18.4 x 38  
11000 lb. & 12000 lb. classes - 20.8 x 38 or 18.4 x 42 max.  
Cut tires are legal.
6. PTO/HYD. - Not required.
7. There will be no water/alcohol injection allowed.
8. 10 mile per hour speed limit enforced. Will be policed by the sled or pace tractor if needed.
9. No weight protruding beyond the rear tires. Hitch must be free and clear and able to reach with hook without excessive work. Sled operator has right to decline hook to any tractor regarding this matter.
10. Plastic blades verses metal blades are acceptable but not mandatory.
11. Snuffers are recommended but not mandatory.
12. Wheelie bars are mandatory and must be the same dimensions as Super Farm.
13. If the speed limit horn sounds, driver may finish pull in a controlled fashion. Failure to do so will result in loss of previous accumulated points.
14. ECITPA reserves the right to make any changes at any time to these rules. All other rules pertaining to contest rules are strictly enforced.

# DIESEL-TURBO SERVICES

## Tractor Repair and Service

1012 1st Ave. N      Mt. Vernon, Iowa  
(319) 895-6092



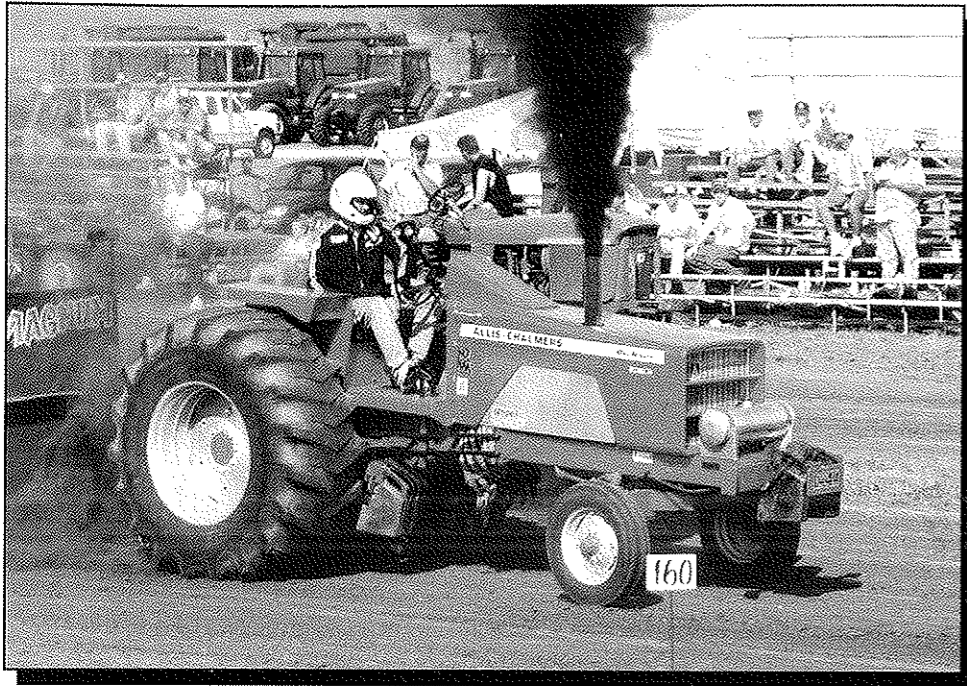

**Mike O'Brien  
and Jay Ballard**  
**Orange Ruffy**  
AC 190XT  
6500 lb. and 7500 lb.  
Super Farm  
Marion and Ladora, Iowa



**Craig Kinzenbaw**  
**Aunt Allis**  
AC 200  
6500 lb.  
Super Farm  
Blairstown, Iowa

## Farmers 4-County Cooperative

Serving You With Offices In  
Belle Plaine \* Blairstown \* Chelsea  
Elberon \* Hartwick \* Ladora \* Luzerne

### 4-County Cooperative Mission Statement

To be a customer focused cooperative providing quality products and service at competitive prices while achieving growth and profitability.

## EIKLENBORG SALVAGE



APLINGTON, IOWA 50604

Mike Eiklenborg  
Owner

Phone (319) 347-2881  
Phone (319) 347-5510  
Fax (319) 347-5554



**Justin Vorwald**  
IH 1256  
11,000 lb.  
Farm Stock  
Epworth, IA

# RABE HARDWARE INC.



**ELECTRICAL • PLUMBING**  
**HEATING • COOLING**  
**GEO THERMAL HEAT PUMPS**  
**319-454-6514**

**QUALITY SERVICE SINCE 1979**



**Dan Schulte**  
**Binder Express**  
 IH 1066  
 8500 lb.  
 Super Farm  
 New Vienna, Iowa



**Doug Jaeger**  
 JD 4430  
 9000 lb. and 11,000 lb.  
 Farm Stock  
 Keota, Iowa

**BARD CONCRETE**

PO. BOX 246 - DYERSVILLE, IA 52040  
 CRUSHED ROCK ■ SAND & GRAVEL ■ AGRICULTURAL LIMESTONE  
 PRECAST CONCRETE CURBS & SPLASH BLOCKS ■ HEATED CONCRETE  
 DYERSVILLE 563-875-7145

MANCHESTER 563-927-4283	CASCADE 563-852-3313	CENTRAL CITY 319-438-6017	ANAMOSA 319-462-4631	HOLY CROSS 563-870-3825
MONTICELLO 319-465-3517	EDGEWOOD 563-928-7014	WYOMING 563-488-2525	CUTTENBERG 563-252-2240	STRAWBERRY POINT 563-933-2321

**STORM STEEL**

6111 6th Street S.W.  
 Box 2902  
 Cedar Rapids, Iowa 52406

Dick Behnken  
 Phone 319-362-0522  
 Fax 319-363-8238

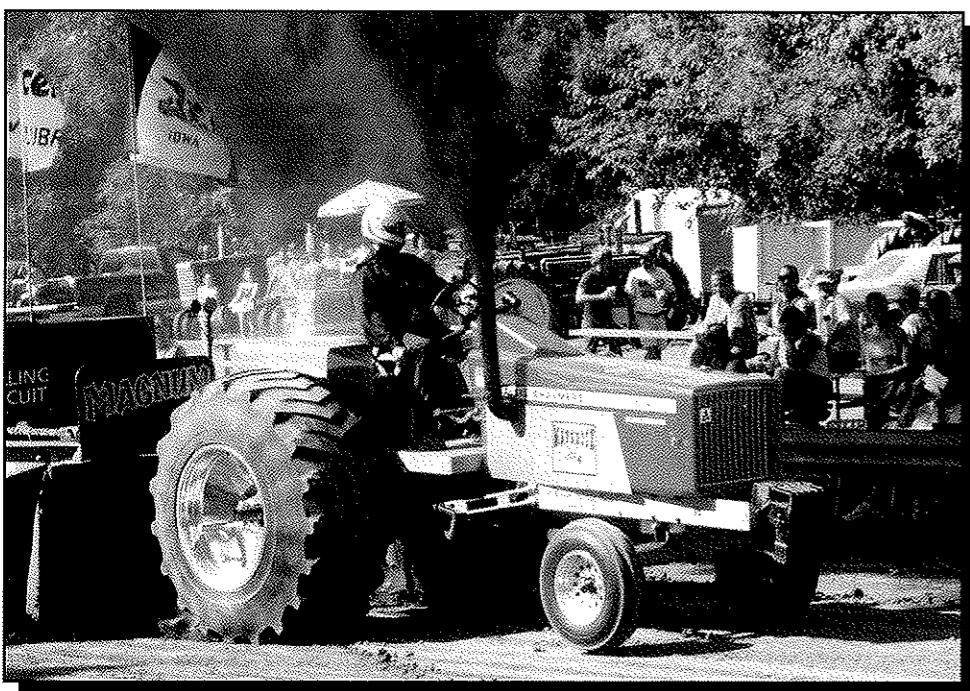

**Mike McElmeel**  
**Maverick**  
 AC 190  
 6500 lb. Super Farm  
 Rockford, Illinois

**GERRY'S FAB. & WELDING INC.**

New Vienna, Iowa  
 800-624-7554 563-921-3445

Gerry's Welding has 25 years experience to serve you. Look what we have to offer!

- **Machining and Welding Services**
- **Extensive Inventory**
  - PTO Parts (Neapco, G&G, Weasler)
  - Steel & Aluminum - Shear & Brake 1/4" x 10'
  - G&G Weld-a-Sprockets & Hubs
  - Auger Flighting
  - Welding Supplies & Airgas Stockpoint
- **Stock and Sell**
  - Kverneland Needle Tines
  - Mensch Rubber Round-up Manure Scrapers
  - Mensch Sand and Sawdust Shooters
- **Manufacturing**
  - Hay\$aver Feeders
  - Heartland Shredders
  - Bale Stabbers with Kverneland Tines
  - Cowlifts
  - Custom Manufacturing
  - Chain Master Roller Chain Counter/Display

**PROTO-CUT TIRE CUTTING**

**"We Produce Winners"**

MACHINE CUT TIRES BY TODD FLUEGEL



**815-865-9106**  
 Rock City, IL



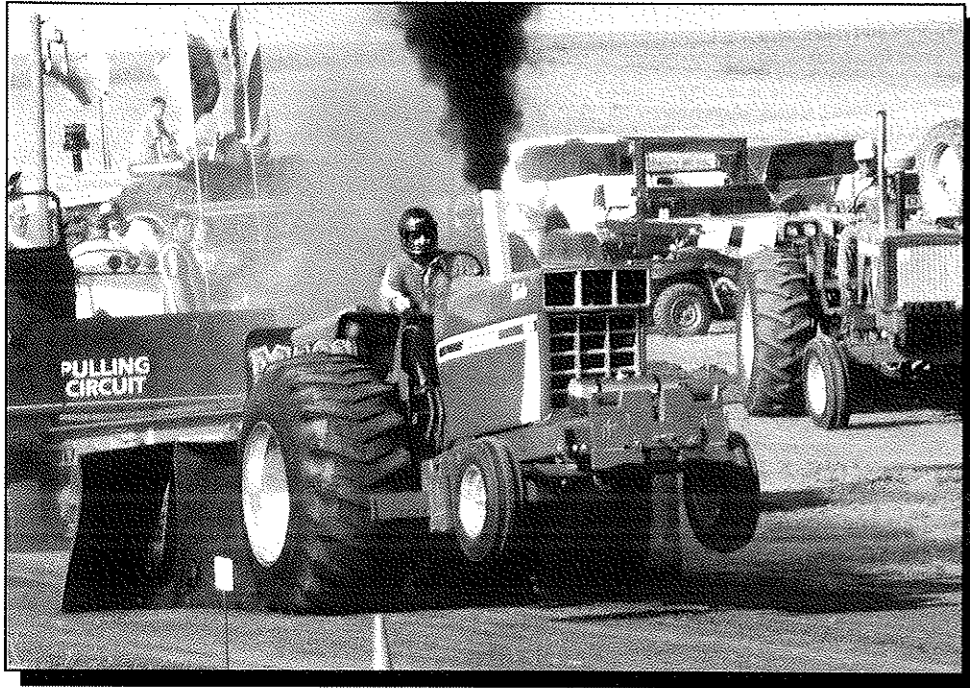

**Bill McEnany**  
**Old Rivals**  
 IH 1066  
 8500 lb. and 9500 lb.  
 Super Farm  
 Ryan, Iowa



**Gary Schulte**  
**Binder Express**  
 IH 1066  
 9500 lb.  
 Super Farm  
 New Vienna, Iowa



**O'GRADY  
 CHEMICAL CORP.**

Fertilizer - Chemicals - Application  
 Trucking - Fuel - LP  
 Tires - Lawn Care  
 200 First Avenue  
 Van Horne, Iowa 52346

**MARTY JUNGE**  
 PRESIDENT

(319) 228-8231

**Steger-Heiderscheit  
 Construction Corp.**

Soil Conservation  
 Terraces - Water Ways - Ponds  
 Highway & Heavy Grading

145 14th Ave. SW Dyersville.....**875-7876**  
 Shop.....875-2404



**Jason Schultz**  
 IH 856  
 11,000 lb. and 12,000 lb.  
 Farm Stock  
 Janesville, WI

**COONROD EQUIPMENT**

**"DON"**

- Farm Equipment
- Parts
- Sales & Service
- Hydraulic Hose Repair
- Clutch & TA's
- Engine Kits
- Injectors
- Front End Parts & Restoration
- Hydraulic & Injection Pumps

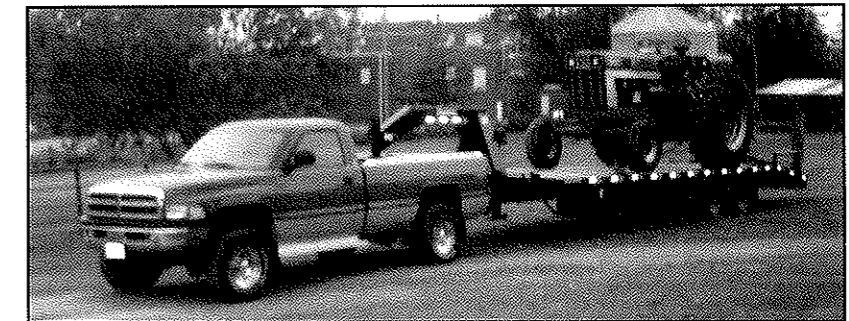

**Pick Up & Delivery**

P.O. Box 525 - 520 Franklin St.  
**Center Point, IA 52213**

**(319) 849-2248**



**Dave Wickman**  
 JD 4030  
 8000 lb. and 9000 lb.  
 Farm Stock  
 Marion, Iowa



**Troy Heiderscheit**  
**No Problem**  
 IH 1066  
 8500 lb.  
 Super Farm  
 Epworth, Iowa

## Blairstown Cafe & Pizzeria

*Serving Good Food Since 1987*

Nicholas & Aliko Mokas  
 318 Locust Street Blairstown, IA 52209  
 319-454-6900

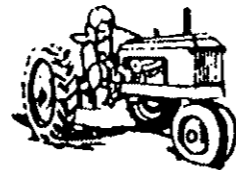

## PAT'S PAINT & REPAIR

*Tractor & Implement Painting  
 Portable Sandblasting*

Pat Hermesen  
 (563) 921-3200 Highway 136 S.  
 Home (563) 921-2107 New Vienna, IA 52065

## New Vienna Ag Automation

7264 Iowa St. P.O. Box 217  
 New Vienna, IA. 52065-0217



Owners Dave Fangmann & Arnie Bries

**Phone (563) 921-2896**



## Benton & Eastern Iowa Farm Feeders Cooperative

"BEIFF"

\*\*\*\*\*

Sunrise "BEIFF"  
 Feedlot, L.L.C.

Wayne Newton  
 General Manager

\*\*

Pam Behounek  
 Accounts Manager

2154 - 78th Street, Box 301  
 Blairstown, Iowa 52209  
 800 472 0675  
 Fax 319 454 0034  
 E-Mail Beiff@aol.com  
 Web Site Beiff.com

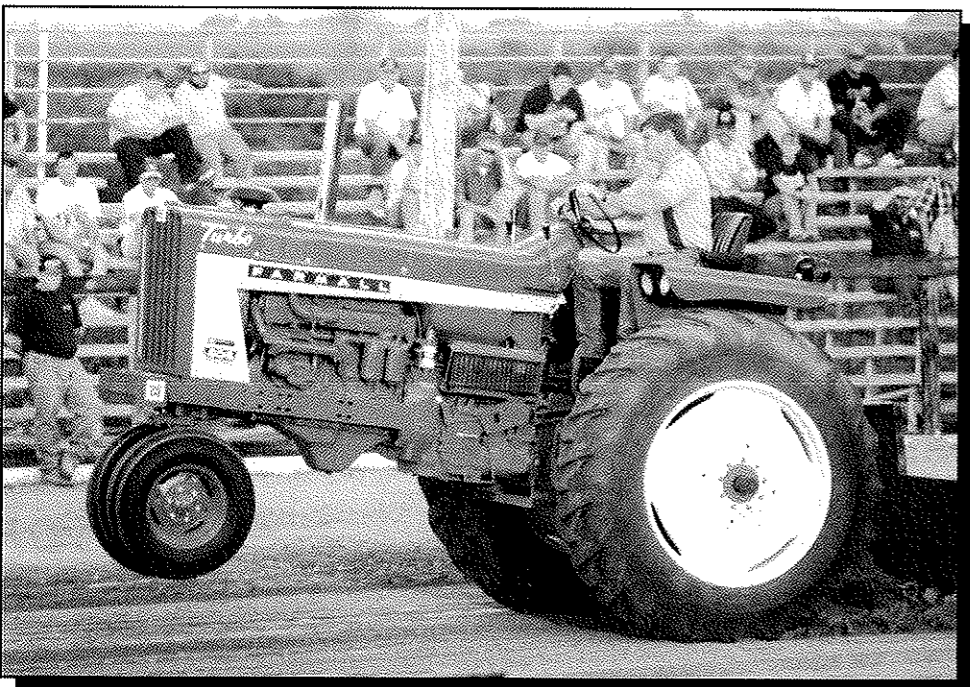

**Rick Van Zante**  
 IH 806  
 9000 lb.  
 Farm Stock  
 Pella, Iowa





**Leo Kinzenbaw**  
**Aunt Allis**  
 AC 200  
 7500 lb.  
 Super Farm  
 Blairstown, Iowa



**Steve McElmeel**  
**Maverick**  
 AC 190  
 6500 lb.  
 Super Farm  
 Lisbon, Iowa

**PAISLEY TRUCKING, INC.**

19917 RT. 52 N.  
 Rickardsville, IA 52039  
 (563) 552-2617

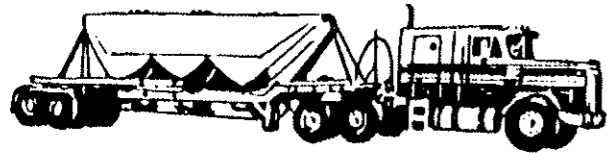

**KNIGHT REPAIR INC.**

Electric & Diesel  
 Starters ■ Alternators

Exit 68  
 116 High St.  
 Elk Run Heights, Iowa  
 50707

J.A. KNIGHT  
 (319) 291-7089

**Steve & Ryan Herrig**

IH 1456  
 11000 lb. & 12000 lb. Farm Stock  
 Lamonte, Iowa

**COMPLETE QUALITY LINE OF FEED, FERTILIZER & SEED**  
**Biological and Organic Lawn Care**  
 ✓ **CHECK US OUT**



**ALL STAR FEEDS, INC.**

Hwy. 136 N. 900 11th St. N.E. • Dyersville, IA  
 563-875-7692 or 1-800-446-7827

*Clete Engelken, owner*



**Mike Baumert**  
 IH 1256  
 11000 lb. & 12000 lb.  
 Farm Stock  
 Harper, Iowa



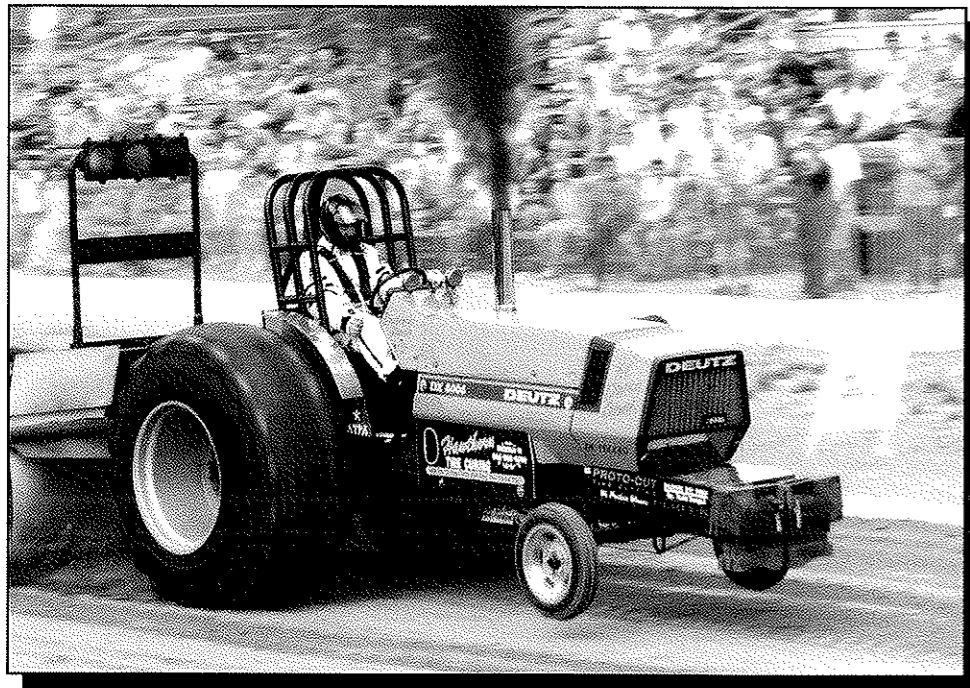

**Larry Hawthorn**  
**Lil Green Giant**  
 Deutz Dx 8006  
 6500 lb. and 7500 lb.  
 Super Farm  
 Monticello, Wisconsin



**Pat Heiderscheit**  
 AC 210  
 11,000 lb. & 12,000 lb.  
 Farm Stock  
 Holy Cross, Iowa



**Hawthorn**  
**TIRE CURING**

Add Life To Your Tires And Keep That Pulling Edge

608-938-4030  
 MONTICELLO, WI

Larry Hawthorn  
 Mark Hawthorn



**STANERSON IMPLEMENT INC.**  
 SALES & SERVICE

Feterl Augers - Bush Hog - Westendorf - Hiniker  
 Landoll - Wilrich - Landpride

Keith Stanerson  
 319-662-4085

Conroy, IA 52220  
 Fax 319-662-4127



**Ray Tillin**  
**My Mother's Kitchen**  
 JD 8410  
 8500 lb. and 9500 lb.  
 Super Farm

**THE B&W THRIFTY PORKMAKER™**



**Hog Feeders**  
 100 Bushel

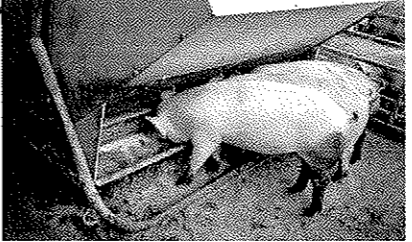

Hog Feeder  
 13 yrs. old →

**K V Jaeger - B&W Distributor**  
 31214 190th Street  
 Keota, Iowa 52248  
**641-636-3452**

**Sunrise Energy Cooperative**

2154 78th Street Telephone 319-454-0033  
 Blairstown, IA 52209 Fax 319-454-9900  
 Email: [senergy@netins.net](mailto:senergy@netins.net)

**John Deere Service by**  
**LINDER REPAIR**  
 Harper, Iowa  
**641-622-3677**

### 8000 lb. Class Farm Stock

PULLER	DISTANCE	RANK
1. Ron Bonert, Earlville, IA - JD 4320	_____	_____
2. Bill Hynick, Eddyville, IA - JD 4010	_____	_____
3. Brian Sieren, Kalona, IA - JD 4010	_____	_____
4. Dave Wickman, Marion, IA - JD 4030	_____	_____
5. _____	_____	_____
6. _____	_____	_____
7. _____	_____	_____
8. _____	_____	_____
9. _____	_____	_____
10. _____	_____	_____
11. _____	_____	_____
12. _____	_____	_____
13. _____	_____	_____

### 9000 lb. Class Farm Stock

PULLER	DISTANCE	RANK
1. Ron Bonert, Earlville, IA - JD 4320	_____	_____
2. Darrin Hynick, Eddyville, IA - JD 4010	_____	_____
3. Doug Jaeger, Keota, IA - JD 4430	_____	_____
4. Brian Sieren, Kalona, IA - JD 4010	_____	_____
5. Rick Van Zante, Pella, IA - IH 806	_____	_____
6. Dave Wickman, Marion, IA - JD 4030	_____	_____
7. _____	_____	_____
8. _____	_____	_____
9. _____	_____	_____
10. _____	_____	_____
11. _____	_____	_____
12. _____	_____	_____
13. _____	_____	_____

**DROST EQUIPMENT INC.**



1401 South 17th Street  
Hwy. 23 South  
Oskaloosa, Iowa 52577  
641-672-2531  
1-800-582-4964  
E-mail: drostequip@JDDealer.com

### 11,000 lb. Class Farm Stock

PULLER	DISTANCE	RANK
1. Mike Baumert, Harper, IA - IH 1256	_____	_____
2. Craig Boot, Pella, IA - IH 1066	_____	_____
3. Tim Gott, Sumner, IA - IH 1206	_____	_____
4. Pat Heidersheit, Holy Cross, IA - AC 210	_____	_____
5. Ryan Herrig, Lamonte, IA - IH 1456	_____	_____
6. Doug Jaeger, Keota, IA - JD 4430	_____	_____
7. Chris Pieffer, Iowa City, IA - IH 1066	_____	_____
8. Jason Schultz, Janesville, WI - IH 856	_____	_____
9. Marvin Stuhrenberg, Mount Auburn, IA - MM 1350	_____	_____
10. Justin Vorwald, Epworth, IA - IH 1256	_____	_____
11. Rick Van Zante, Pella, IA - IH 806	_____	_____
12. _____	_____	_____
13. _____	_____	_____

### 12,000 lb. Class Farm Stock

PULLER	DISTANCE	RANK
1. Mike Baumert, Harper, IA - IH 1256	_____	_____
2. Craig Boot, Pella, IA - IH 1066	_____	_____
3. Mike Gott, Sumner, IA - IH 1206	_____	_____
4. Pat Heidersheit, Holy Cross, IA - AC 210	_____	_____
5. Steve Herrig, Lamonte, IA - IH 1456	_____	_____
6. Chris Pieffer, Iowa City, IA - IH 1066	_____	_____
7. Jason Schultz, Janesville, WI - IH 856	_____	_____
8. Marvin Stuhrenberg, Mount Auburn, IA - MM 1350	_____	_____
9. Jim Vorwald, Epworth, IA - IH 1256	_____	_____
10. _____	_____	_____
11. _____	_____	_____
12. _____	_____	_____
13. _____	_____	_____

INTERSTATE BATTERY SYSTEM OF EAST CENTRAL IOWA  
16825 BOCKENSTEDT RD. • DYERSVILLE, IA 52040



**Kirk & Gayle Snedden** (563) 921-3322  
Distributor/Owner Fax (563) 921-4313



### 6500 lb. Class Super Farm

PULLER	DISTANCE	RANK
1. Duane Conrad, Epworth, IA - JD 4020	_____	_____
2. Ron Fier, Maquoketa, IA - IH 666	_____	_____
3. Larry Hawthorn, Monticello, WI - Deutz DX 8006	_____	_____
4. Dave Jensen, Van Horne, IA - Ford 7910	_____	_____
5. Craig Kinzenbaw, Blairstown, IA - AC 200	_____	_____
6. Mike McElmeel, Rockford, IL - AC 190	_____	_____
7. Barry Mohr, Ladora, IA - IH 656	_____	_____
8. Mike O'Brien/Jay Ballard, Marion, IA - AC 190XT	_____	_____
9. Gary Willenborg, New Vienna, IA - JD 4010	_____	_____
10. _____	_____	_____
11. _____	_____	_____
12. _____	_____	_____
13. _____	_____	_____

### 7500 lb. Class Super Farm

PULLER	DISTANCE	RANK
1. Duane Conrad, Epworth, IA - JD 4020	_____	_____
2. Ron Fier, Maquoketa, IA - IH 666	_____	_____
3. Gary Gaul, Worthington, IA - JD 4010	_____	_____
4. Larry Hawthorn, Monticello, WI - Deutz DX 8006	_____	_____
5. Dave Jensen, Van Horne, IA - Ford 7910	_____	_____
6. Leo Kinzenbaw, Blairstown, IA - AC 200	_____	_____
7. Steve McElmeel, Lisbon, IA - AC 190	_____	_____
8. Mike O'Brien/Jay Ballard, Marion, IA - AC 190XT	_____	_____
9. Tom Quinlan, Ladora, IA - IH 656	_____	_____
10. _____	_____	_____
11. _____	_____	_____
12. _____	_____	_____
13. _____	_____	_____

**Farm Supply**  
Mike Kluesner  
Manager  
Sales & Service



- Conveyors
- Silo Unloaders
- Barn Cleaners
- Drinking Cups
- Free Stalls
- Electrical

2082 Main Street  
P.O. Box 86  
New Vienna, Iowa 52065  
Office Phone: 563-921-2110  
Home: 563-921-2445  
Fax: 563-921-4425

### 8500 lb. Class Super Farm

PULLER	DISTANCE	RANK
1. Rick Evans, Springville, IA - IH 966	_____	_____
2. Jim Friedrichs, Sterling, IL - JD 4560	_____	_____
3. Troy Heidersheit, Epworth, IA - IH 1066	_____	_____
4. Kevin Hulsebus, Amana, IA - IH 1066	_____	_____
5. Bill McEnany, Ryan, IA - IH 1066	_____	_____
6. Dan Schulte, New Vienna, IA - IH 1066	_____	_____
7. Mike Schultz, Bremen, IN - AC D21	_____	_____
8. Paul Vande Noord, Pella, IA - IH 1486	_____	_____
9. Ray Tillin, IA - JD 8410	_____	_____
10. _____	_____	_____
11. _____	_____	_____
12. _____	_____	_____
13. _____	_____	_____

### 9500 lb. Class Super Farm

PULLER	DISTANCE	RANK
1. Rick Evans, Springville, IA - IH 966	_____	_____
2. Jim Friedrichs, Sterling, IL - JD 4560	_____	_____
3. Lyle Heidersheit, Epworth, IA - IH 1066	_____	_____
4. Kevin Hulsebus, Amana, IA - IH 1066	_____	_____
5. Bill McEnany, Ryan, IA - IH 1066	_____	_____
6. Gary Schulte, New Vienna, IA - IH 1066	_____	_____
7. Mike Schultz, Bremen, IN - AC D21	_____	_____
8. Paul Vande Noord, Pella, IA - IH 1486	_____	_____
9. Ray Tillin, IA - JD 8410	_____	_____
10. _____	_____	_____
11. _____	_____	_____
12. _____	_____	_____
13. _____	_____	_____

**EM CLUTCH MASTERS**  
TRUCK • AUTOMOTIVE • FARM  
Original Equipment Parts, Best in the Midwest



Flywheel Grinding  
Pilot Bearings  
T.O. Bearings  
New and Remanufactured



**Phone:**  
(319) 233-7336 1-800-363-9825  
2117 Falls Avenue • Waterloo, Iowa 50701





**Rick Evans**  
**Bad Things**  
 IH 966  
 8500 lb. and 9500 lb.  
 Super Farm  
 Springville, Iowa



**Bill Hynick**  
 JD 4010  
 8000 lb.  
 Farm Stock  
 Eddyville, Iowa

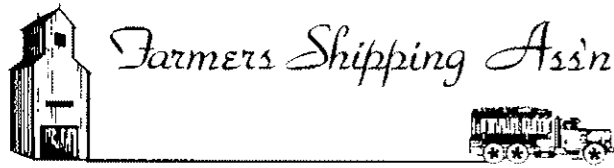

*Farmers Shipping Ass'n*

Organized to Save the Farmers Money

303 3rd Street N.E.  
 Dyersville, Iowa 52040  
 (563) 875-7953

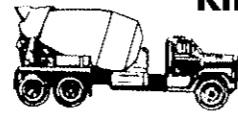

**Kimm's Ready Mix, Inc.**  
**& Concrete**  
**Construction**

Agricultural - Residential - Commercial

**Dale P. Kimm Trucking**  
 Aglime - Rock - Sand

Dale P., Joe, and Jon  
 Blairstown, Iowa  
 319-454-6200

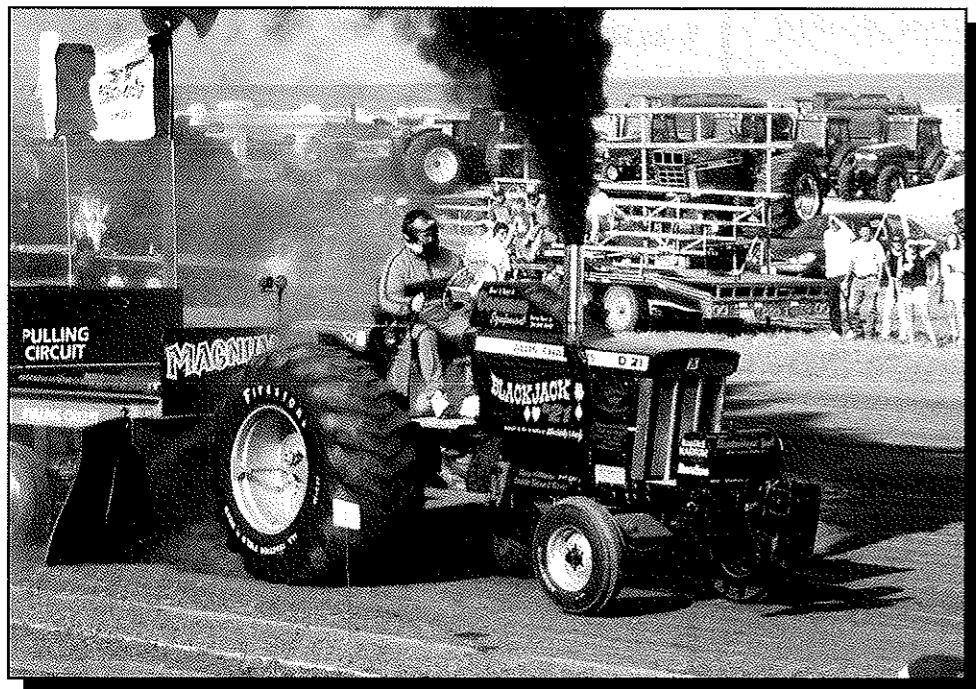

**Mike Schultz**  
**Blackjack 21**  
 AC D21  
 8500 lb. and 9500 lb.  
 Super Farm  
 Bremen, Indiana

## Shaul & Ullerich Chevrolet Co.

**319-454-6413**

601 Locust St. N.W.

*New and Used*  
*Cars and Pickups*  
*Sales, Service, Parts*



## Shaul & Ullerich Body Shop

**319-454-6190**

106 Iowa St. N.E.



*Painting*  
*and*

*Collision Repair*  
*Specialists*

Blairstown, Iowa



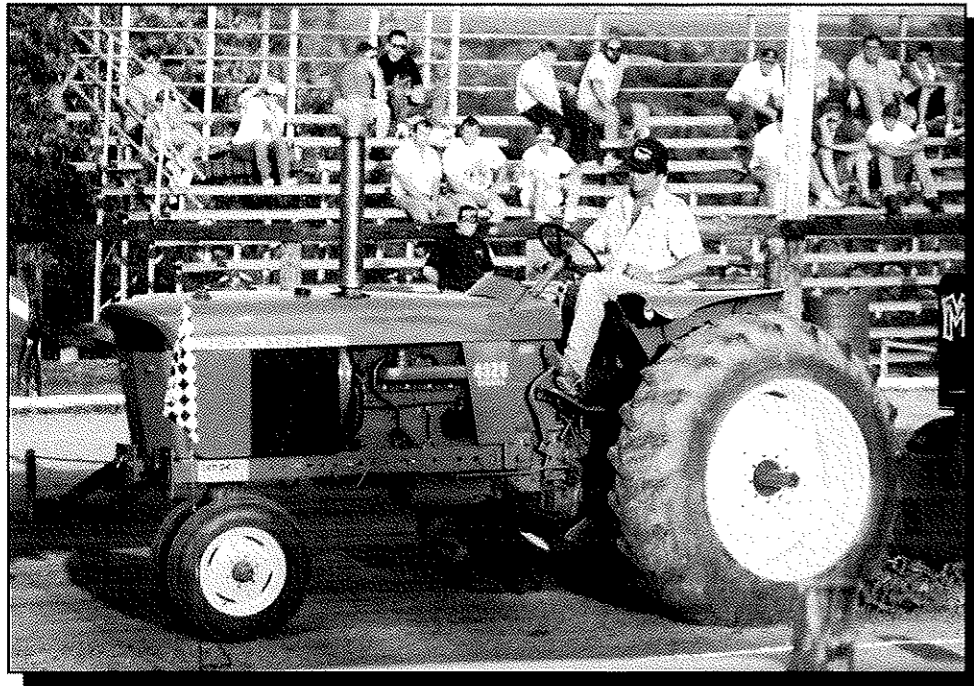

**Ron Bonert**  
 JD 4320  
 8000 lb. and 9000 lb.  
 Farm Stock  
 Earlville, Iowa



**Lyle Heiderscheit**  
**No Problem**  
 IH 1066  
 9500 lb.  
 Super Farm  
 Epworth, Iowa

## GARY'S REPAIR

Ag Equipment Service & Repair

Over 20 Years Experience

(319) 642-5025

GARY CONRAD  
 Owner

245 Western Ave.  
 Marengo, Iowa 52301

## KIMM'S SINCLAIR SERVICE



604 Locust N.E.  
 Blairstown, Iowa  
 (319) 454-6551

Marty O. Kimm



**Brian Sieren**  
 JD 4010  
 8000 lb. and 9000 lb.  
 Farm Stock  
 Kalona, Iowa

# Sauerkraut Days 2001 Demo Derby & Tractor Pull

**Blairstown, Iowa**  
**Labor Day Weekend - Friday, Saturday & Sunday**  
**August 31, September 1 & 2**



### FRIDAY

Demo Derby  
 Beer Tent  
 Pork Products  
 Concessions

### SATURDAY

Parade at 10:00 am  
 Free Sauerkraut &  
 Wieners  
 D & B Shows Carnival  
 Kid's Games in the Park  
 Kid's Bike & Trike Races  
 Cow Chip Bingo  
 Stage Show  
 Co-ed Ball Tournament  
 Car Show  
 Steak Supper at 5:00 pm  
 Kid's Dance at 6:00 pm  
 Beer Tent All Day  
 Concessions  
 Street Dance at 9:00 pm

### SUNDAY

Tractor Pull  
 Beer Tent  
 Concessions  
 Rolle Bolle

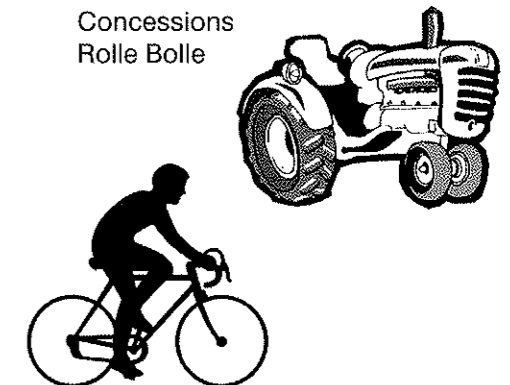





**Gary Gaul**  
**Binder Grinder**  
 JD 4010  
 7500 lb.  
 Super Farm  
 Worthington, Iowa



**Duane Conrad**  
**Indian Outlaw**  
 JD 4020  
 6500 lb. and 7500 lb.  
 Super Farm  
 Epworth, Iowa

**HUB CITY IMPLEMENT CO. INC.**  
 and  
**ROWLEY EQUIPMENT**

*Now Two Locations  
 Where Customer Satisfaction is #1.*



**JOHN DEERE**

**Hub City Imp. Co. Inc.**  
 1900 So. Frederick  
 Oelwein, IA 50662  
 (319) 283-4371  
 1-800-498-4371

**Rowley Equipment**  
 1965 290th St.  
 Rowley, IA 52329  
 (319) 938-2222  
 1-800-567-5890

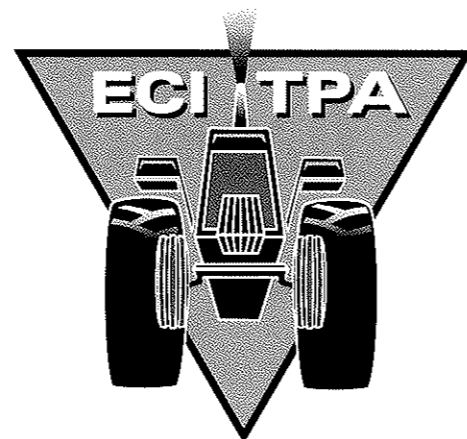

**BECOME A PART  
 OF ECITPA!  
 Associate Memberships**

Any tractor pulling fan can become an associate member of East Central Iowa Tractor Pullers Association. For only \$25 you receive a ECITPA hat or t-shirt, 2 ECITPA decals, and mailings of the latest club information. Just come to the announcer's stand or call Tom Quinlan at 319-628-4713.



**HELLE FARM EQUIPMENT, INC.**  
 Hwy 136 N., Dyersville, Iowa 52040  
 563-875-7154

AGCO-Allis, AGCO-White, New Idea, AGCO-Gleaner,  
 New Holland, Brillion, Arts-Way, and H&S



**YES! WE ARRANGE FINANCING**

The MUSTANG 2050 has the versatility you need, with the power and performance that you want. The 2050 features a smooth, riding extended wheelbase, 1550 lbs lift capacity (SAE), 18.5 GPM auxiliary hydraulic output, and a 49 horse diesel engine. If you need more lift capacity, add the optional weight kit to raise the lift capacity to 1650 lbs. Test drive one today and experience the MUSTANG advantages.

**BRUNKAN EQUIPMENT**  
 224 2nd Ave. N.E., Dyersville, IA, 563-875-2434



**Paul Vande Noord**  
**Never Enough**  
 IH 1486  
 8500 lb. and 9500 lb.  
 Super Farm  
 Pella, Iowa

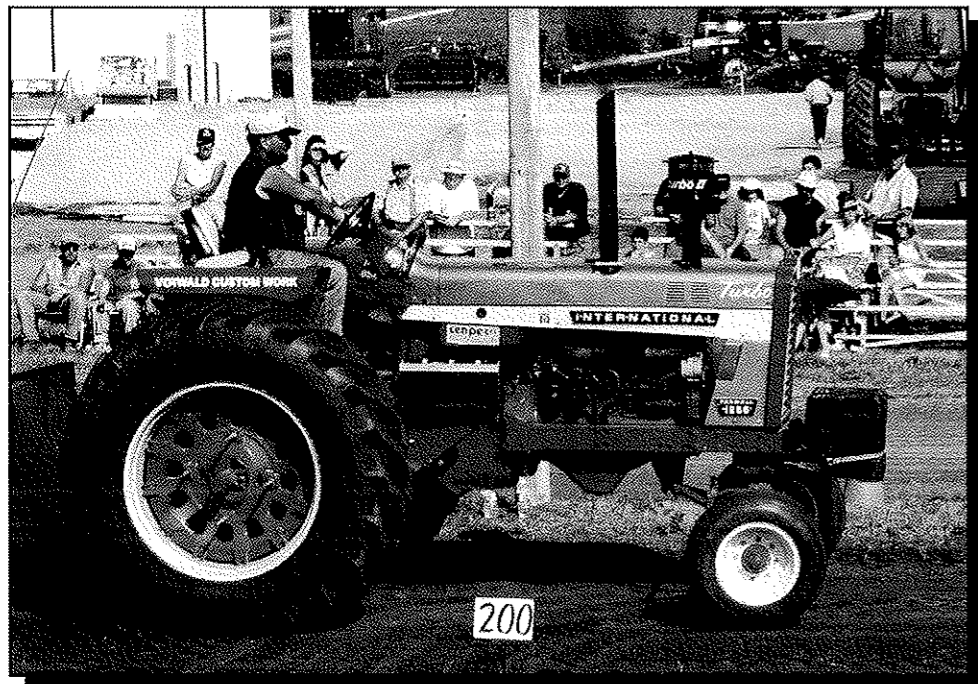

**Jim Vorwald**  
 IH 1256  
 12,000 lb.  
 Farm Stock  
 Epworth, Iowa



**Tim & Mike Gott**  
 IH 1206  
 11,00 lb. & 12,000 lb.  
 Farm Stock  
 Sumner, Iowa



**LEON FUNKE**  
 District Sales Mgr.

*Producers Hybrids...providing the farmer  
 with quality seed at a reasonable price  
 Corn, Soybeans and Alfalfa*

RESIDENCE:  
 29713 Old Castle Road  
 Dyersville, IA 52040  
 (888) 335-3348 or (563) 875-2475

Box C  
 Battle Creek, NE 68715  
 (402) 675-2975



**Horsfield Construction, Inc.**

Pat Horsfield

505 East Main St.  
 P.O. Box 305  
 Epworth, IA 52045

Office (563) 876-3335  
 Fax (563) 876-3487  
 Truck (563) 590-4471  
 Mobile (563) 590-4474  
 pat@horsfieldinc.com



**Ron Fier**  
**Red Legend**  
 IH 666  
 6500 lb. and 7500 lb.  
 Super Farm  
 Maquoketa, Iowa

# WE'VE GOT YOUR NUMBER

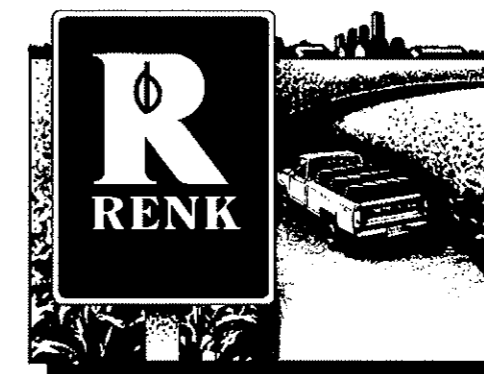

Your Renk dealer  
 has the right hybrid  
 numbers that  
 perform best in this  
 area...and on your  
 farm. Check out the full line of

Renk test plot in your area.

Renk corn hybrids,  
 as well as Renk  
 alfalfa and soybean  
 varieties. And be  
 sure to ask about a

Schulte Bros. (563) 921-3605

Dan and Gary Schulte (563) 921-3009

or call John Heying - District Sales Manager

**1-800-BUY-RENK**





**Tom Quinlan**  
**Malfunction**  
**Junction**  
 IH 656  
 7500 lb.  
 Super Farm  
 Oxford, Iowa



**Craig Boot**  
 IH 1066  
 11000 lb. & 12000 lb.  
 Farm Stock  
 Pella, IA

## RURSCH SPECIALTIES

12716-148th Ave. West  
 Taylor Ridge, IL 61284  
**(309) 795-1502**  
**Fax: (309) 795-1514**

Crower Clutches  
 All Type Clutches Rebuilt  
 Grizzley Tire Cutting  
 Tire Grinding Discs

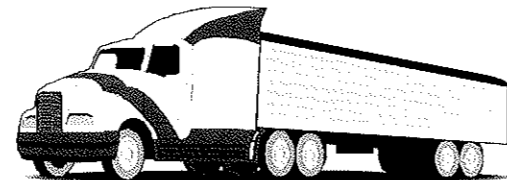

### Kinzenbaw Trucking

Blairstown, IA 52209

Leo 319-454-6565 Craig 319-454-6322  
 Mobile 319-551-1702 Mobile 319-551-2536

Fax 319-454-9070

Corn • Soybeans • Grains • Short or Long Hauls

## Peavey

**Peavey Company**  
 P.O. Box 1480  
 505 East 7th Street  
 Dubuque, IA 52001

**Delbert Uhlik**  
 General Manager  
 Bus: (563) 556-4245  
 Cell: (563) 599-5036  
 Wats: (800) 747-4245  
 Fax: (563) 556-1924



a ConAgra Company

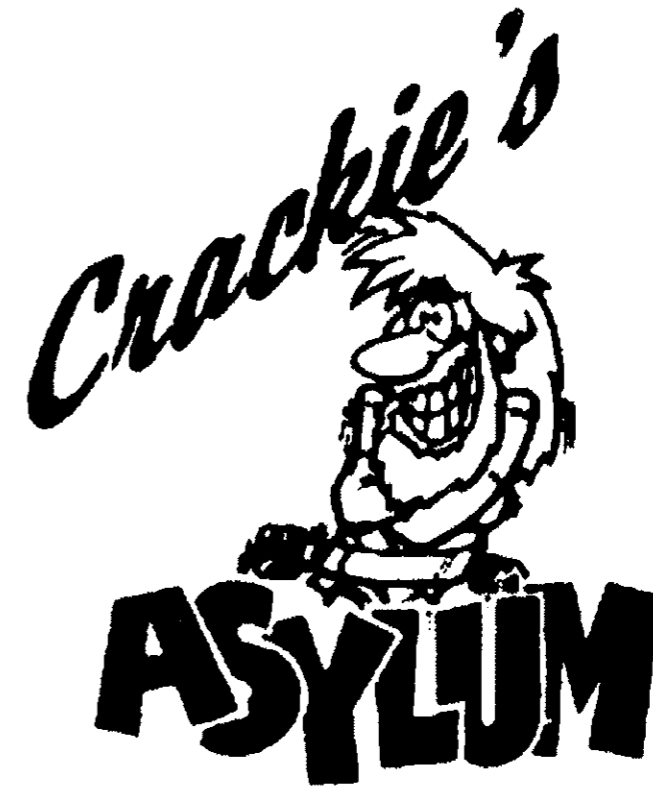

**(319) 454-6351**

Blairstown, Iowa

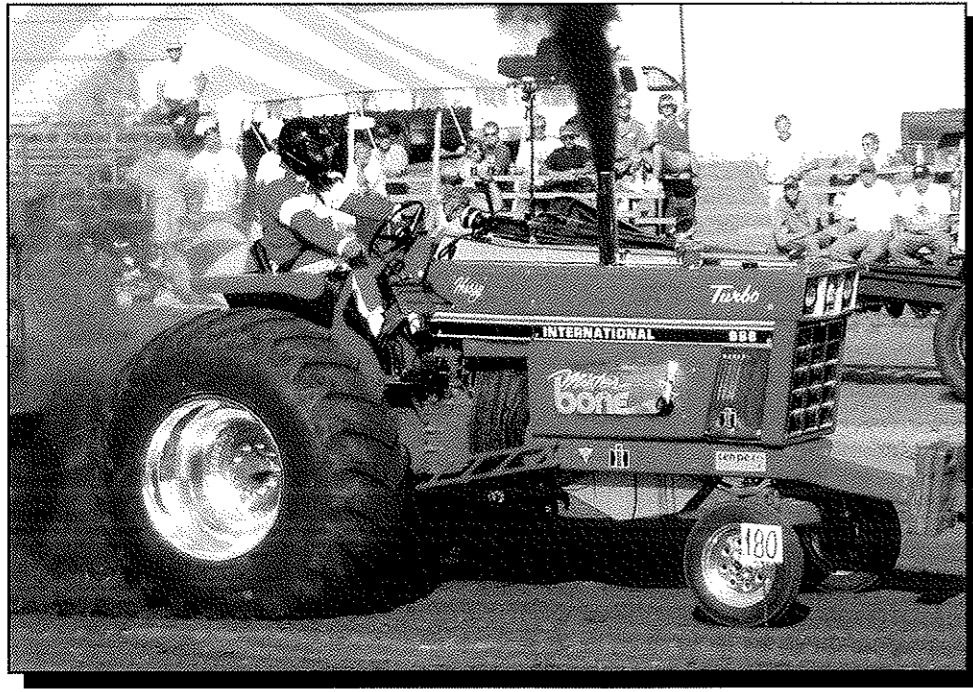

**Kevin Hulsebus**  
**Mister Bone**  
 IH 1066  
 8500 lb. and 9500 lb.  
 Super Farm  
 Amana, Iowa



**Dave Jensen**  
**Uncle Eddie**  
 Ford 7910  
 6500 lb. and 7500 lb.  
 Super Farm  
 Van Horne, Iowa

## Kusel Trucking



*For all hopper and van hauling*

Stacey Kusel  
 1090 70th Street  
 Elberon, Iowa 52225

319-551-0721 Cell Phone  
 319-439-3208 Office



VIGORTONE® AG PRODUCTS, INC.

## Blairstown Feed Mill

Box 146  
 Blairstown, IA 52209  
**319-454-6433**

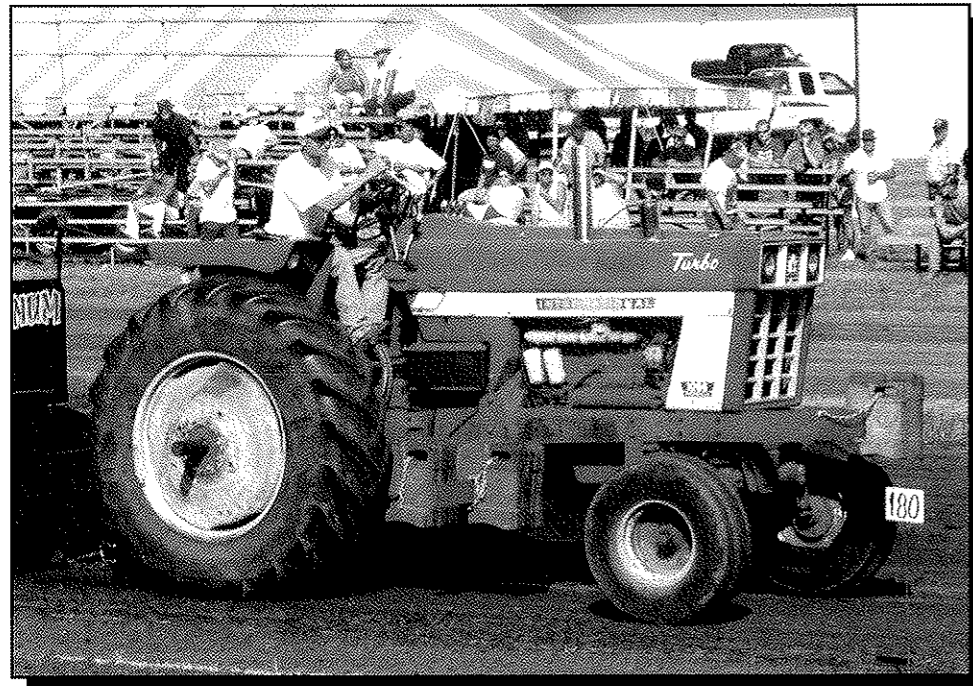

**Chris Pieffer**  
 IH 1066  
 11000 lb. & 12000 lb.  
 Farm Stock  
 Iowa City, Iowa

# BARON MOTOR SUPPLY

**AUTOMOTIVE  
MACHINE  
SHOP**

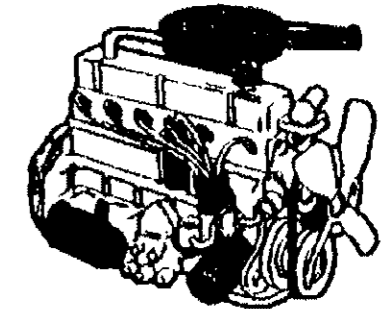
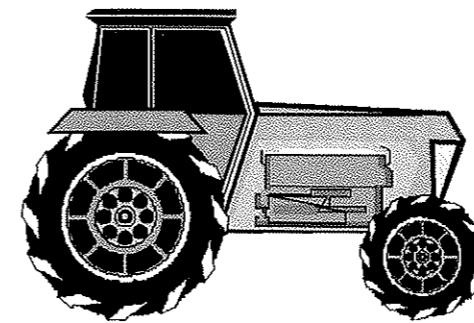

224 3rd Ave. S.W.  
 Cedar Rapids, IA 52404

(319) 365-4601  
 800-779-4601



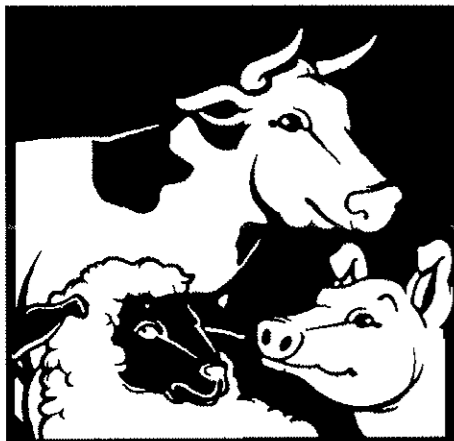

*We are proud to be serving the needs of the area's livestock and crop farmers. At Simon's we offer the latest developments in agriculture based on your individual needs.*



**Simon's Grain & Feed Service, Inc.**

319-927-6050 • Manchester • 1-800-798-2580

**Hopkinton Feed & Grain, Inc.**

319-926-2760 • Hopkinton • 1-800-475-2580

**Farley Fertilizer, Inc.**

319-744-3330 • Farley

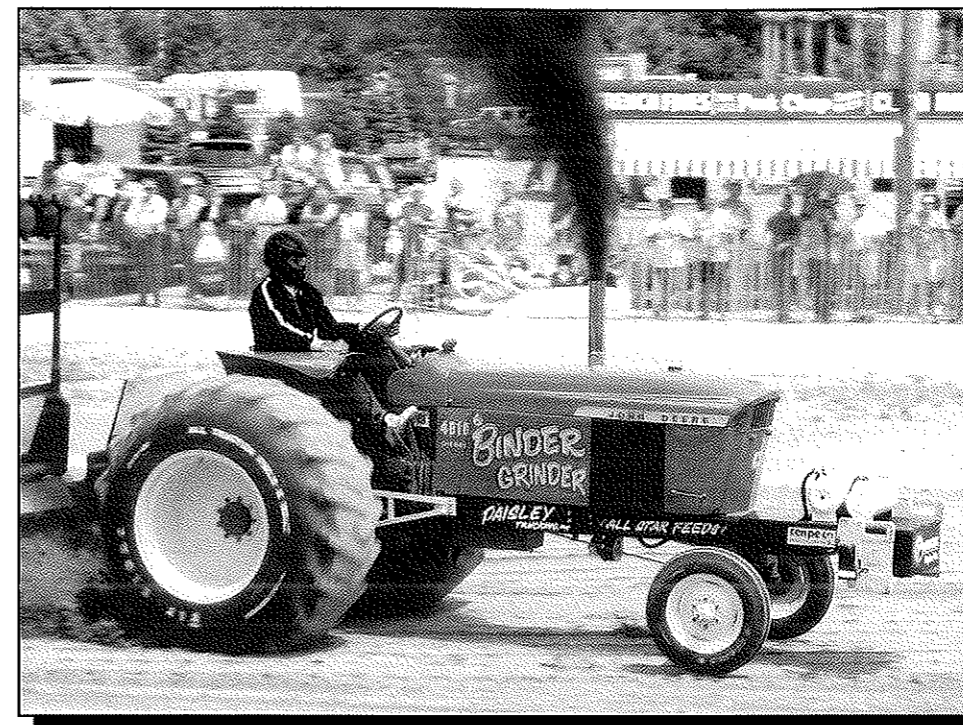

**Gary Willenborg  
Binder Grinder**  
JD 4010  
6500 lb.  
Super Farm  
New Vienna, Iowa

**Kinze Farms**  **Home of Aunt Allis**

**Leo Kinzenbaw**  
Independent Dealer

**DEKALB Genetics Corporation**  
2045 75TH ST., DR. • BLAIRSTOWN, IA 52209  
HOME (319) 454-6565 • MOBILE (319) 551-1702

**SILKER'S**   
**General Merchandise**

GENERAL  ELECTRIC

**101 WEST MAIN**  
**EPWORTH, IOWA 52045-0284**

 **Sigourney Tractor & Implement**

**CHAD HEISDORFFER**  
Sales Coordinator

P.O. Box 265  
Sigourney, IA 52591  
515-622-3838  
Toll Free 877-833-4444  
Home Phone 515-622-9965  
After Hours Parts Cell Phone 515-660-1099  
After Hours Service Cell Phone 515-660-0586

Striving to EARN Your Business Every Day

**Swiss Valley**   
FARMS

The Good For You Company.™

A dairy cooperative producing excellent dairy products from their members' quality milk.



**Marv Stuhrenberg**  
 MM 1350  
 11,000 lb. and 12,000 lb.  
 Farm Stock  
 Mount Auburn, Iowa



**Barry Mohr**  
**Malfunction Junction**  
 IH 656  
 6500 lb.  
 Super Farm  
 Ladora, Iowa

**Jack Walker**  
**Chrysler Plymouth Dodge**  
 Hwy. 92 W. Sigourney  
 641-622-2020  
 1-800-747-9150

**Taylor Bros. Construction**  
 John Taylor Joe Taylor  

  
 Phone 563-870-3565  
 23750 Heiderscheit Road  
 Holy Cross, IA 52053  
*Dozing - Tiling - Scraper - Backhoe*

  
**Ronn L. Bridgewater**  
 Field Agronomy Tech Support  
 Home: 319/454-6547  
 Mobile: 319/361-2728  
 PO Box 134  
 Blairstown, IA 52209  
 Bridgewater.Ronn@patriotseed.com  
**Patriot Seed 800/643-1518**

 **KINZE** **Woods**   
 ALLIS GLEANER WHITE NEW IDEA   **NEW HOLLAND GEMINI GENESIS VERSATILE**  
**CENTRAL IOWA FARM STORE, INC.**  
 Box 561 - 203 Iowa Ave. W. - Marshalltown, IA 50158  
**515-753-3996**  
 Lyle Jons - Owner Res: 752-1432 Bill Casady - Owner Res: 752-7761

**PROFIT FROM OUR EXPERIENCE**  
**Crop Production Services**  
  
 We handle all your seed, chemical and fertilizer needs.  
    
 Stop in or give us a call today!  
 Farley 744-3822 Dyersville 875-2711  
 800-251-0623 Worthington 855-2711  
 Talk To One Of Our **Certified Crop Advisors**  
 Terry Bockenstedt ■ Al Wessels  
 Gary Mensen ■ Steve Deppe  
CARGILL Hybrid Seeds The Leader in Forage Quality Crops  
WYFFELS HYBRIDS The High Q Experts in Corn  
NK New to South America Drive Performance The Best at Placing The Right Seed in The Right Field

**Heat Your Home With Corn**  
**Snow Flame Corn Stove**  
 Call 563-875-8287  
 31973 Olde Castle Road ■ Dyersville, Iowa 52040  



**Jim Fredrichs**  
**Wild Buck**  
 JD 4560  
 8500 lb. and 9500 lb.  
 Super Farm  
 Sterling, Illinois





**Darrin Hynick**  
 JD 4010  
 8000 lb. and 9000 lb.  
 Farm Stock  
 Eddyville, Iowa



**Kevin Hulsebus**  
*Mister Twister*  
 IH 666  
 6500 lb. and 7500 lb.  
 Super Farm  
 Amana, Iowa

**CASE IH**

**Quad County Implement Inc.**  
 2116 76th St., Blainstown, Iowa

*Your full service Dealer*

1-800-779-7140      Visit our website:  
 319-454-6281      [Http://www.netins.net/showcase/quad](http://www.netins.net/showcase/quad)  
 Fax (319) 454-6160      Email us at:  
    Quad@netins.net

**cen-pe-co**  
 Central Petroleum Company  
 Since 1911

**Dennis H. Flear**      (319) 395-9662  
 Lubrication & Coating Specialist  
 District Representative  
 3310 Timber Valley Court NE  
 Cedar Rapids, IA 52402

**Vorwald Custom Work**  
 22553 East Pleasant Grove Road  
 Epworth, IA 52045  
 (563) 876-3412

**LINK HYDRAULIC INC.**

**BOB LINK**  
 President

12910 West Side Court  
 Dubuque, Iowa 52003  
 563.556.2551  
 800.446.2551  
 563.556.8244/Fax

**Coleman Equipment**

**Spring & Fall Consignment Sale**  
**Custom Farming**  
**Wyffels Seed Corn**  
**Ottillie Seed Beans**  
**Good Used Equipment Year Around**

**319-435-2531**      **Coggon, IA**

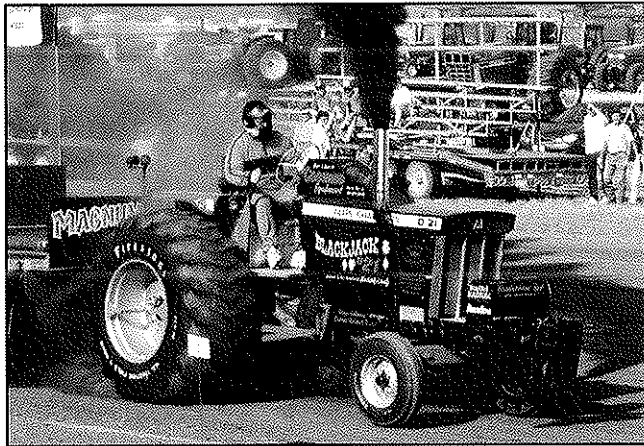

**Mike Schultz**  
Blackjack 21

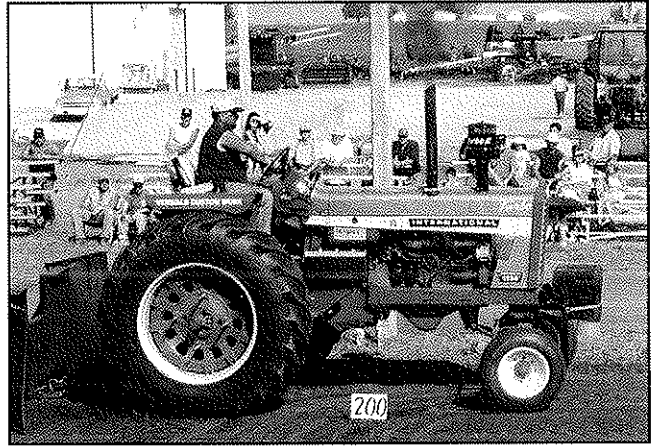

**Jim Vorwald**  
IH 1256

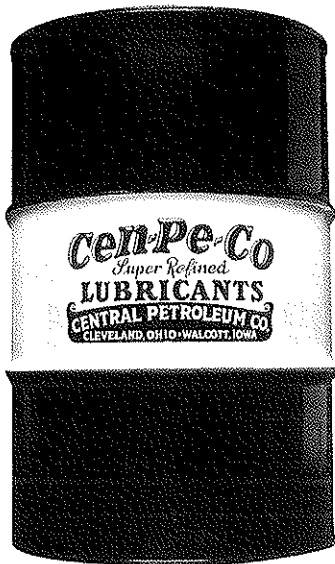

# **cen-pe-co**

**Lubricants & Coatings**

- ◆ Superior Performance Engine Oils
- ◆ Patented Fuel Additives
- ◆ Higher Torque Gear Lubricants
- ◆ Strong Hold Greases
- ◆ Longer Life Metal & Wood Building Paints
- ◆ Aluminum Fibre Roof & Bin Coatings

## **Central Petroleum Co.**

Cleveland, OH • Walcott, IA

[www.cen-pe-co.com](http://www.cen-pe-co.com)

**1-800-553-1891**